



CUSTOM SPECIFICATION DRAWING

ACO Polycrete Pty Ltd.
134-140 Old Bathurst Road
Emu Plains, NSW 2750
Tel: 02 4747 4000
Fax: 02 4747 4060
e: technical@acoaus.com.au

DRWG# VS0001
www.acoaus.com.au

Custom Heelguard Grate System - Vinyl Seal with End Outlet

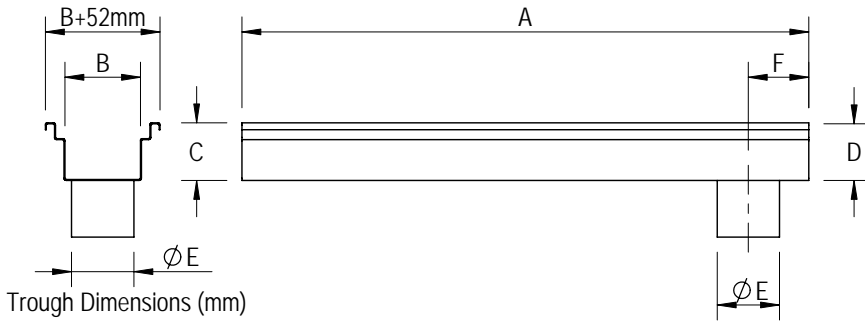

Required Information (enter details in space provided)		
A	Overall Length	mm
B	Internal Width	mm
C	Upstream Overall Depth	mm
D	Downstream Overall Depth	mm
E	Outlet Diameter	mm
F	Outlet Location	mm

Endplate Options (select an endplate)

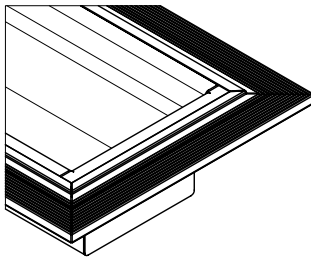

Rolled Over Endplate

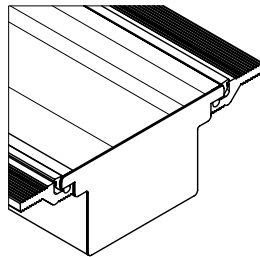

Simple Flat Endplate

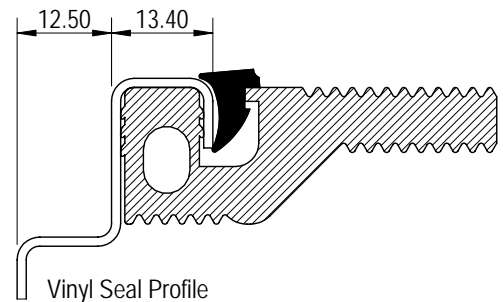

Grate Options (select a grate)

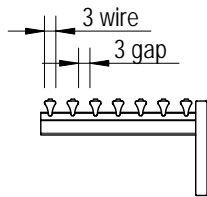
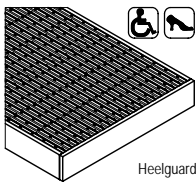

#300A Heelguard 3x3 (Anti-slip)
 Class A

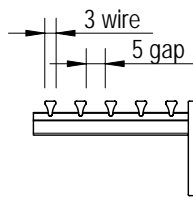

#118 Heelguard 3x5
 Class A
 Class B
 Class C

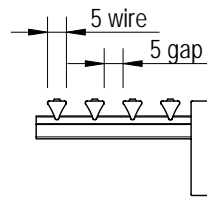

#160A Heelguard 5x5 (Anti-slip)
 Class A
 Class B
 Class C



SPECIFICATION CLAUSE

ACO Polycrete Pty Ltd.
134-140 Old Bathurst Road
Emu Plains, NSW 2750
Tel: 02 4747 4000
Fax: 02 4747 4060
e: technical@acoaus.com.au

DRWG# VS0001
www.acoaus.com.au

Custom Heelguard Grate System - Vinyl Seal with End Outlet

The floor drain troughs are to be ACO Stainless System as supplied by ACO Polycrete Pty Ltd. All components used within the scope of the system shown on **Drawing No(s)**. _____*. All work should be carried out strictly in accordance with the installation details set out on **Drawing No.** _____*.

All components are to be manufactured from austenitic stainless steel **Grade 304/316/(other)** _____*.

System to be supplied with **Constant Depth/Sloped*** troughs with the overall depths specified as in **Drawing No.** _____*.

Troughs to be supplied complete with **Vinyl Seal** edge profile, in the specified **lengths/layout*** according to

Drawing No. _____*. Position and nominal size of outlet as detailed in

Drawing No. _____*.

Grates to be Heelguard **#300A(Anti-slip) / #160A(Anti-slip) / #118***, **with/without*** bolt locking devices.

***Please delete or complete where appropriate.**