



CUSTOM SPECIFICATION DRAWING

ACO Polycrete Pty Ltd.
134-140 Old Bathurst Road
Emu Plains, NSW 2750
Tel: 02 4747 4000
Fax: 02 4747 4060
e: technical@acoaus.com.au

DRWG# VS2002
www.acoaus.com.au

System 200 - Vinyl Seal with Centre Outlet

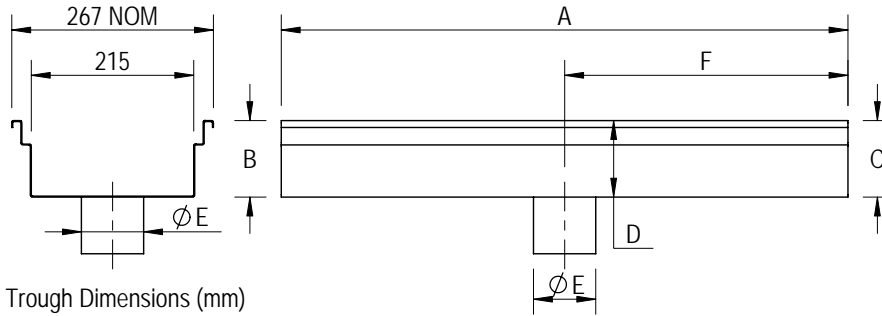

Required Information (enter details in space provided)		
A	Overall Length	mm
B	Upstream 1 Overall Depth	mm
C	Upstream 2 Overall Depth	
D	Downstream Overall Depth	mm
E	Outlet Diameter	mm
F	Outlet Location	mm

Trough Dimensions (mm)

Endplate Options (select an endplate)

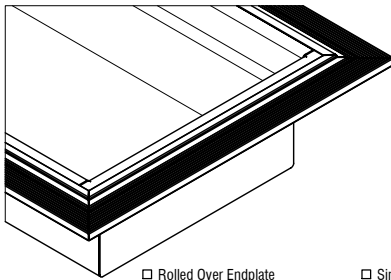

Rolled Over Endplate

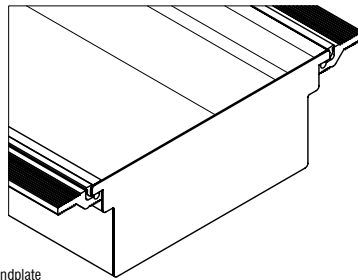

Simple Flat Endplate

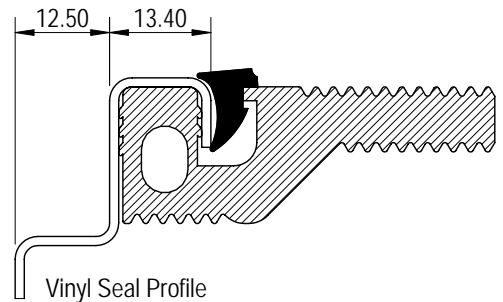

Vinyl Seal Profile

Grate Options (select a grate)

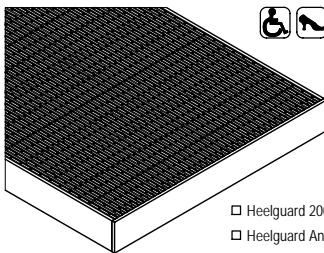

Heelguard 200 Class A
 Heelguard Antislip 200 Class B

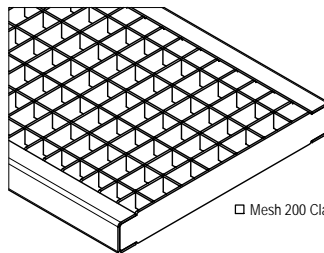

Mesh 200 Class C

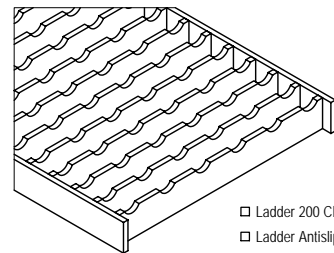

Ladder 200 Class D
 Ladder Antislip 200 Class D



SPECIFICATION CLAUSE

ACO Polycrete Pty Ltd.
134-140 Old Bathurst Road
Emu Plains, NSW 2750
Tel: 02 4747 4000
Fax: 02 4747 4060
e: technical@acoaus.com.au

DRWG# VS2002
www.acoaus.com.au

System 200 - Vinyl Seal with Centre Outlet

The floor drain troughs are to be ACO Stainless **System 200** as supplied by ACO Polycrete Pty Ltd. All components used within the scope of the system shown on **Drawing No(s)**. _____*. All work should be carried out strictly in accordance with the installation details set out on **Drawing No.** _____*.

All components are to be manufactured from austenitic stainless steel **Grade 304/316/(other)** _____*.

System to be supplied with **Constant Depth/Sloped*** troughs with the overall depths specified as in **Drawing No.** _____*.

Troughs to be supplied complete with **Vinyl Seal** edge profile, in the specified **lengths/layout*** according to

Drawing No. _____*. Position and nominal size of outlet as detailed in

Drawing No. _____*.

Grates to be **Part No.** _____*, **with/without*** bolt locking devices.

*Please delete or complete where appropriate.