



# CUSTOM SPECIFICATION DRAWING

ACO Polycrete Pty Ltd.  
134-140 Old Bathurst Road  
Emu Plains, NSW 2750  
Tel: 02 4747 4000  
Fax: 02 4747 4060  
e: technical@acoaus.com.au

DRWG# VS3001  
www.acoaus.com.au

## System 300 - Vinyl Seal with End Outlet

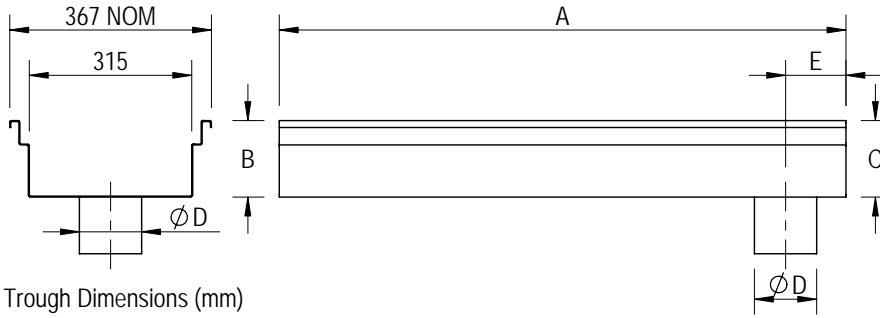

Required Information (enter details in space provided)		
A	Overall Length	mm
B	Upstream Overall Depth	mm
C	Downstream Overall Depth	mm
D	Outlet Diameter	mm
E	Outlet Location	mm

Endplate Options (select an endplate)

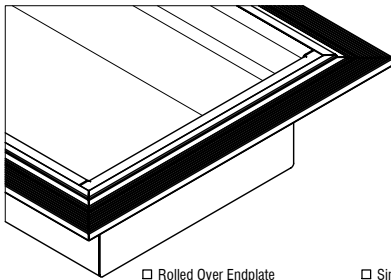

Rolled Over Endplate

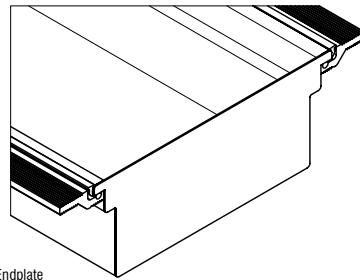

Simple Flat Endplate

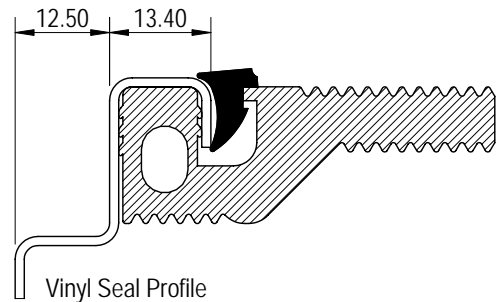

Grate Options (select a grate)

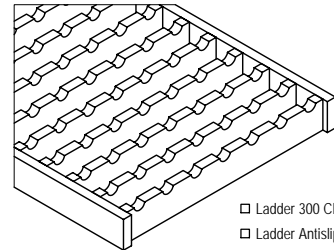
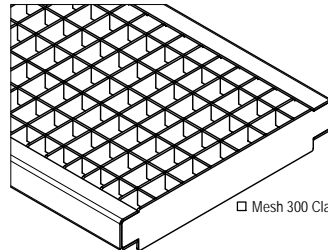
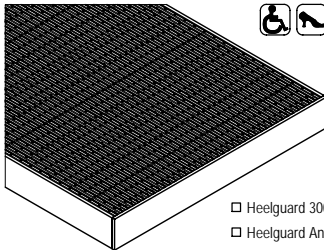

# SPECIFICATION CLAUSE

ACO Polycrete Pty Ltd.  
134-140 Old Bathurst Road  
Emu Plains, NSW 2750  
Tel: 02 4747 4000  
Fax: 02 4747 4060  
e: technical@acoaus.com.au

DRWG# VS3001  
www.acoaus.com.au

## System 300 - Vinyl Seal with End Outlet

The floor drain troughs are to be ACO Stainless **System 300** as supplied by ACO Polycrete Pty Ltd. All components used within the scope of the system shown on **Drawing No(s)**. \_\_\_\_\_\*. All work should be carried out strictly in accordance with the installation details set out on **Drawing No.** \_\_\_\_\_\*.

All components are to be manufactured from austenitic stainless steel **Grade 304/316/(other)** \_\_\_\_\_\*.

System to be supplied with **Constant Depth/Sloped**\* troughs with the overall depths specified as in **Drawing No.** \_\_\_\_\_\*.

Troughs to be supplied complete with **Vinyl Seal** edge profile, in the specified **lengths/layout**\* according to **Drawing No.** \_\_\_\_\_\*.

Position and nominal size of outlet as detailed in **Drawing No.** \_\_\_\_\_\*.

Grates to be **Part No.** \_\_\_\_\_\*, **with/without**\* bolt locking devices.

\*Please delete or complete where appropriate.