

Polymer Concrete Cable Pits





Polycrete® (polymer concrete) pits have excellent insulation properties, high mechanical strengths, chemical resistance and zero water absorption, which makes them ideal as electrical and communications enclosures. Lighter and therefore less cumbersome than traditional concrete pits, only large polymer concrete pits require special lifting equipment.

Features

- Manufactured from chemical and corrosion resistant lightweight polymer concrete
- Pit bodies – 100% non metallic, insulated construction with an electrical resistivity rating of $1 \times 10^8 \Omega / \text{sq}$. (identical to concrete without steel reinforcing)
- Easy to fit and seal dividing walls
- Easy to handle & cut for cable entry penetration
- Range of anti-slip lids and access covers for all load classes to Class G (AS 3996)
- OH&S friendly steel lids not exceeding 25kg
- IP ratings up to IP4X (AS 60529) - enclosure protection against ingress
- Aesthetic, recessed access covers for infill of pavement material to complement or match surrounding pavement
- Steel lids and access covers are hot dip galvanised to AS 4680
- Access covers are weather resistant

Key

These icons appear on the following product pages to easily identify the lid and cover options available with each pit/riser.

-  Polymer concrete pit with lid
-  Polymer concrete pit with riser and lid
-  Polymer concrete pit with access cover
-  Polymer concrete pit with riser and access cover



Anti-slip polymer concrete lids ensure a complete enclosure comprising non metallic components.



Walls designed for easy cable entry penetration.



ACO's patented **PowerLok®** lid with choice of security options is available for a wide range of pit sizes.

Applications

- *Carparks*
- *Streetscapes*
- *Sports venues*
- *Driveways*
- *Industrial sites*
- *Urban distribution*
- *Airports*



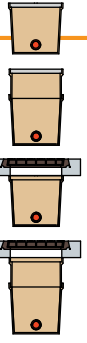

Type 33 Pit

Length	340mm		Up to 740mm (1 riser) 1,040mm (2 risers)
Width	340mm		
Depth	440mm		

Product Selection Steps

Once pit type is determined:

1. Determine if riser(s) is required.
2. Select lid or access cover (adds additional depth) to suit project application.

POLYMER CONCRETE

Lids

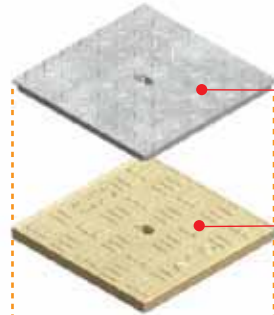

Steel lid (AS 3996 Class B)
 AS/NZS 4586 Slip Resistance Rating R10.
 IP4X (AS 60529) protection against ingress of foreign objects if fitted with universal plug.
 If a locking lid is required, contact ACO.

Polymer concrete lid (AS 3996 Class A)
 AS/NZS 4586 Slip Resistance Rating R10.
 IP4X (AS 60529) protection against ingress of foreign objects if fitted with universal plug.

Riser

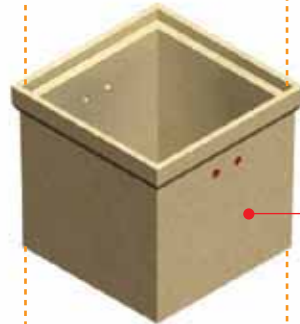

Note: Access covers fit above pit/riser, refer to pg 80 for installation guidelines.

Optional riser to increase pit depth, riser rebate is identical to pit rebate and with lid, offers the same IP protection. Can be cut to required height. ACO recommends no more than 2 risers. Each riser adds 300mm depth.

Pit

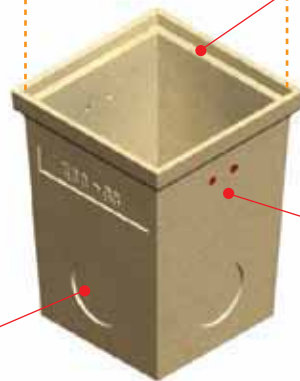

Lids fit into rebate at top of pit, whilst access covers must be installed in a cast in situ concrete collar.

Polymer concrete pit construction offers excellent strength to weight ratio, excellent electrical resistivity, low porosity, and high resistance to chemicals, weathering, biological attack.

Holesaw guides for conduit entry - holes can be cut anywhere on side walls. Maximum number of holes recommended per pit is limited by conduit quantity and size. Contact ACO for guidance.

Weather Resistant Access Covers

All access covers have IP4X (AS 60529) protection against ingress of foreign objects. **Rhinocast®** access covers offer water & gas tightness to AS 3996.

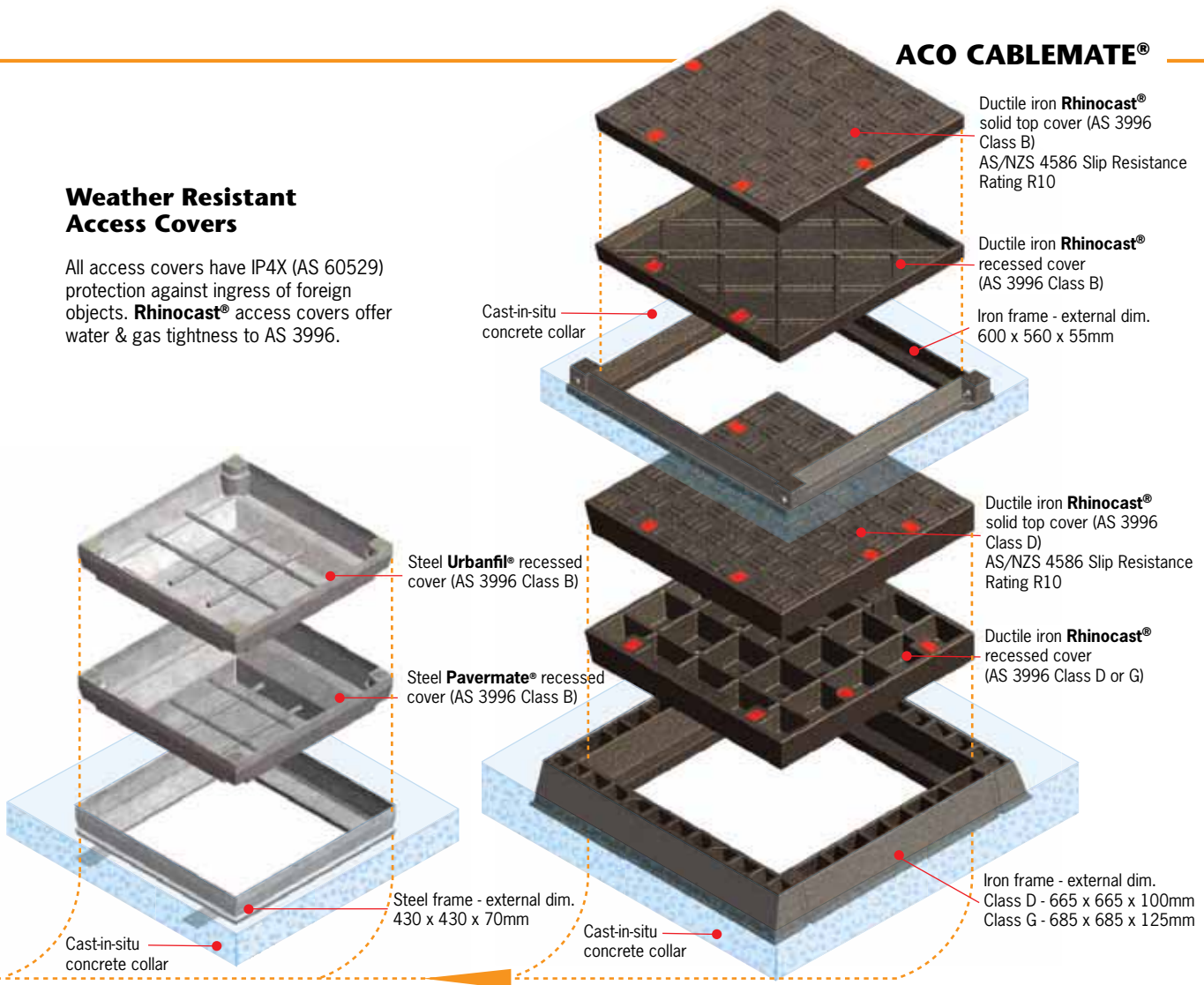

Type 33 Pit Parts List⁴

Description	Part No.	Weight (kg)		
Type 33 polymer concrete pit	75244	19		
Type 33 polymer concrete riser (adds 300mm to pit depth)	75265	15		
Lids & Covers	Cover ¹	Total		
Polymer concrete lid (AS 3996 Class A) - Blank	75282	6	6	
Polymer concrete lid (AS 3996 Class A) - Communications	75299	6	6	
Polymer concrete lid (AS 3996 Class A) - Electricity	75303	6	6	
Steel lid (AS 3996 Class B)	73320	3	3	
Steel Urbanfil® recessed cover (AS 3996 Class B) ²	81686	7	11	
Steel Pavermate® recessed cover (AS 3996 Class B) ²	81297	8	12	
Ductile iron Rhinocast® recessed cover (AS 3996 Class B) ³	85014	28	40	
Ductile iron Rhinocast® solid top cover (AS 3996 Class B) ³	85249	20	44	
Ductile iron Rhinocast® recessed cover (AS 3996 Class D) ³	89013	42	83	
Ductile iron Rhinocast® solid top cover (AS 3996 Class D) ³	89268	46	86	
Ductile iron Rhinocast® recessed cover (AS 3996 Class G) ³	87016	86	138	

Notes:

- Lid & access cover weights are provided as lifting weight (individual cover parts) and total weight. Recessed cover weights do not include pavement infill; for approx. lifting weight - **Urbanfil®/Pavermate®** covers - multiply weight by '7'; **Rhinocast®** covers multiply weight by '1.5'.
- Optional brass edging (Specify 'BE' after part number).
- Optional locking, brass or stainless steel edging in 12mm or 40mm heights (Specify 'BE' or 'SS' and height after part number).
- For Accessories (e.g. identification plates, divider brackets, cable hanger brackets see pg 43).

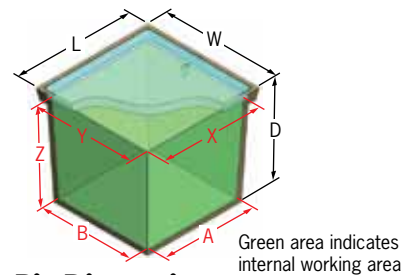

Pit Dimensions

Internal working area (mm)	(mm)
A	235
B	235
X	280
Y	280
Z	405
Overall dimensions (mm)	(mm)
L	340
W	340
D	440

Notes:

- Using risers will increase pit depth (Z & D) by depth of riser.
- Access covers will increase depth of pit by height of concrete collar - allowance should be made for concrete collar during pit installation. See pg 82 for excavation details.

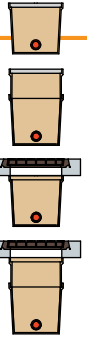

Type 45 Pit

Length	510mm		Up to	
Width	510mm		900mm (1 riser)	
Depth	600mm		1,200mm (2 risers)	

Product Selection Steps

Once pit type is determined:

1. Determine if riser(s) is required.
2. Select lid or access cover (adds additional depth) to suit project application.

POLYMER CONCRETE

Lids

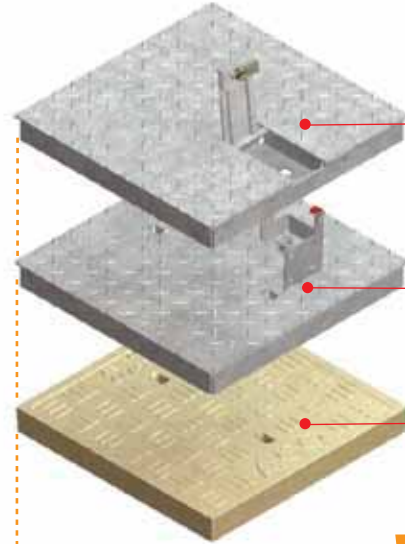

Steel **PowerLok**® lid (AS 3996 Class B)
AS/NZS 4586 Slip Resistance Rating R10.
IP2XD (AS 60529) protection against ingress of foreign objects when hatch is closed.

Steel lid (AS 3996 Class B)
AS/NZS 4586 Slip Resistance Rating R10.
IP4X (AS 60529) protection against ingress of foreign objects if fitted with universal plug.

Polymer concrete lid (AS 3996 Class A)
AS/NZS 4586 Slip Resistance Rating R10.
IP4X (AS 60529) protection against ingress of foreign objects if fitted with universal plug.

Riser



Note: Access covers fit above pit/riser, refer to pg 80 for installation guidelines.

Optional riser to increase pit depth, riser rebate is identical to pit rebate and with lid, offers the same IP protection. Can be cut to required height. ACO recommends no more than 2 risers. Each riser adds 300mm depth.

Pit

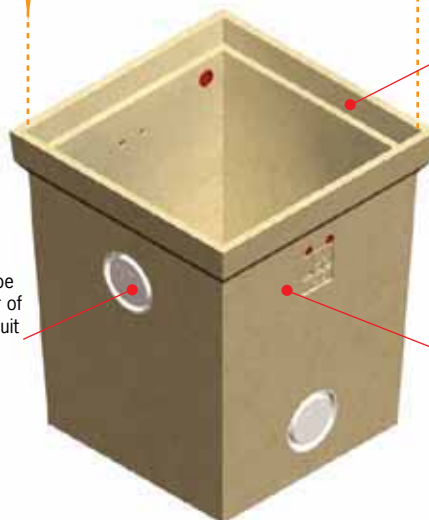

Lids fit into rebate at top of pit, whilst access covers must be installed in a cast in situ concrete collar.

Holesaw guides for conduit entry - holes can be cut anywhere on side walls. Maximum number of holes recommended per pit is limited by conduit quantity and size. Contact ACO for guidance.

Polymer concrete pit construction offers excellent strength to weight ratio, excellent electrical resistivity, low porosity, and high resistance to chemicals, weathering, biological attack.

Weather Resistant Access Covers

All access covers have IP4X (AS 60529) protection against ingress of foreign objects. **Rhinocast®** access covers offer water & gas tightness to AS 3996.

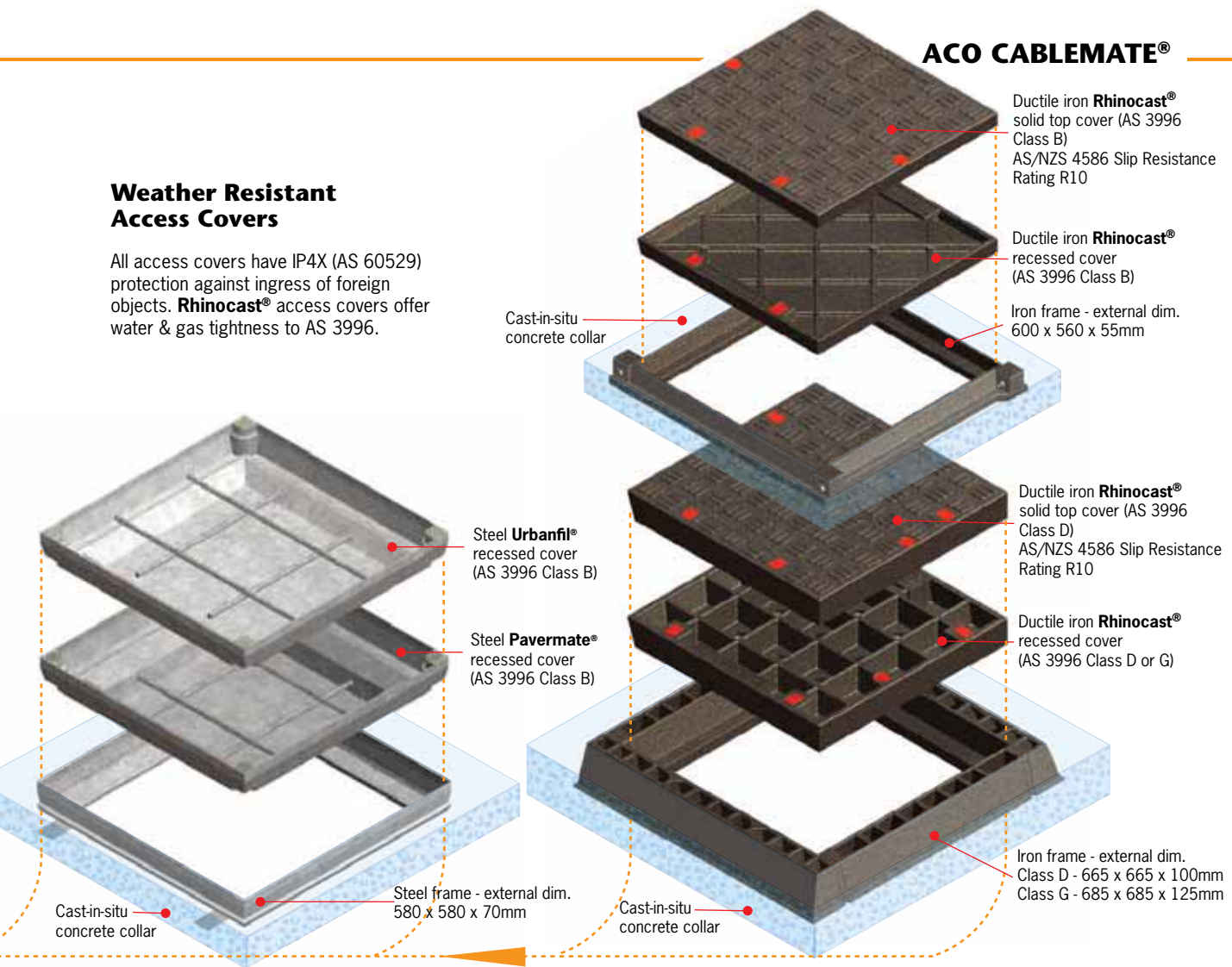

Type 45 Pit Parts List⁶

Description	Part No.	Weight (kg)		
Type 45 polymer concrete pit	75362	45		
Type 45 polymer concrete riser (adds 300mm to pit depth)	75389	26		
Lids & Covers			Cover¹	Total
Polymer concrete lid (AS 3996 Class A) - Blank	75400	15	15	
Polymer concrete lid (AS 3996 Class A) - Communications	75414	15	15	
Polymer concrete lid (AS 3996 Class A) - Electricity	75427	15	15	
Steel lid (AS 3996 Class B)	74521	11	11	
Steel PowerLok® lid (AS 3996 Class B) ^{2,3}	74530	14	14	
Steel Urbanfil® recessed cover (AS 3996 Class B) ⁴	81520	11	16	
Steel Pavermate® recessed cover (AS 3996 Class B) ⁴	81305	12	18	
Ductile iron Rhinocast® recessed cover (AS 3996 Class B) ⁵	85014	28	40	
Ductile iron Rhinocast® solid top cover (AS 3996 Class B) ⁵	85249	20	44	
Ductile iron Rhinocast® recessed cover (AS 3996 Class D) ⁵	89013	42	83	
Ductile iron Rhinocast® solid top cover (AS 3996 Class D) ⁵	89268	46	86	
Ductile iron Rhinocast® recessed cover (AS 3996 Class G) ⁵	87016	86	138	

Notes:

- Lid & access cover weights are provided as lifting weight (individual cover parts) and total weight. Recessed cover weights do not include pavement infill; for approx. lifting weight - **Urbanfil®/Pavermate®** covers - multiply weight by '7'; **Rhinocast®** covers multiply weight by '1.5'.
- All lids are supplied with brackets and support bars where applicable.
- PowerLok®** lids supplied with locking bolt (padlock not supplied).
- Optional brass edging (Specify 'BE' after part number).
- Optional locking, brass or stainless steel edging in 12mm or 40mm heights (Specify 'BE' or 'SS' and height after part number).
- For Accessories (e.g. identification plates, divider brackets, cable hanger brackets see pg 43).

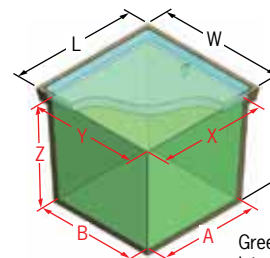

Pit Dimensions

Internal working area	(mm)
A	385
B	385
X	435
Y	435
Z	530
Overall dimensions	(mm)
L	510
W	510
D	600

Notes:

- Using risers will increase pit depth (Z & D) by depth of riser.
- Access covers will increase depth of pit by height of concrete collar - allowance should be made for concrete collar during pit installation. See pg 82 for excavation details.

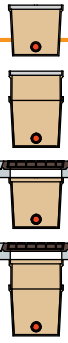

Type 66 Pit

Length	665mm		Up to 920mm (1 riser) 1,220mm (2 risers)
Width	665mm		
Depth	620mm		

Type 66H Pit

Length	665mm		Up to 1,215mm (1 riser) 1,515mm (2 risers)
Width	665mm		
Depth	915mm		

Product Selection Steps

Once pit type is determined:

1. Determine if riser(s) is required.
2. Select lid or access cover (adds additional depth) to suit project application.

Lids

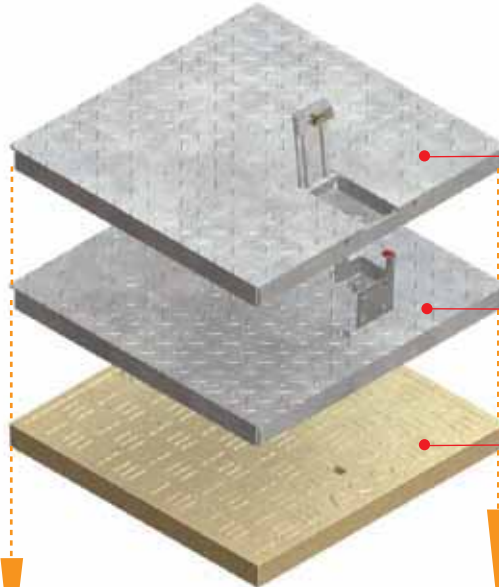

Steel **PowerLok**® lid (AS 3996 Class B)
 AS/NZS 4586 Slip Resistance Rating R10.
 IP2XD (AS 60529) protection against ingress of foreign objects when hatch is closed.

Steel lid (AS 3996 Class B)
 AS/NZS 4586 Slip Resistance Rating R10.
 IP4X (AS 60529) protection against ingress of foreign objects if fitted with universal plug.

Polymer concrete lid (AS 3996 Class A)
 AS/NZS 4586 Slip Resistance Rating R10.
 IP4X (AS 60529) protection against ingress of foreign objects if fitted with universal plug.

Riser

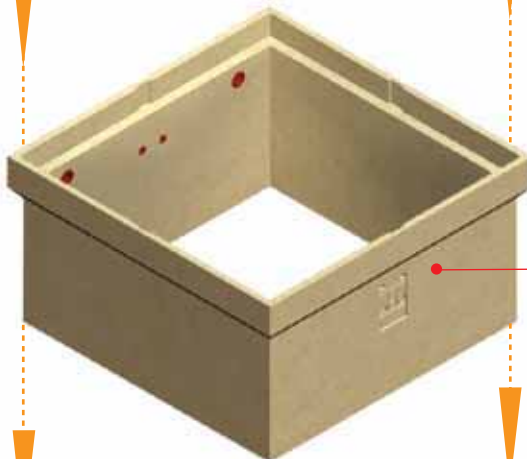

Note: Access covers fit above pit/riser, refer to pg 80 for installation guidelines.
 Optional riser to increase pit depth, riser rebate is identical to pit rebate and with lid, offers the same IP protection. Can be cut to required height. ACO recommends no more than 2 risers. Each riser adds 300mm depth.

Pit

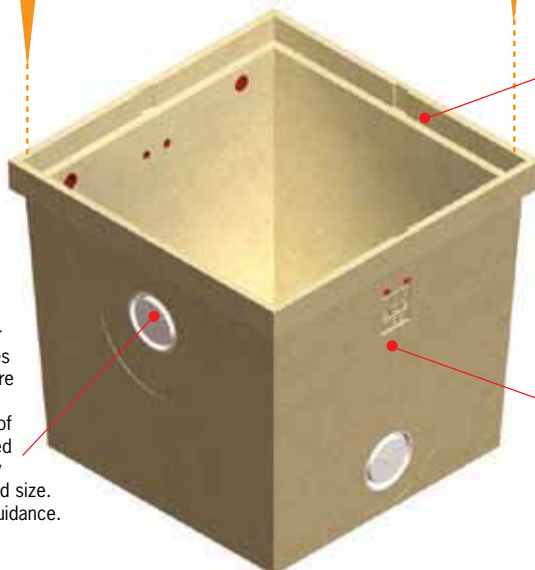

Lids fit into rebate at top of pit, whilst access covers must be installed in a cast in situ concrete collar.

Holesaw guides for conduit entry - holes can be cut anywhere on side walls. Maximum number of holes recommended per pit is limited by conduit quantity and size. Contact ACO for guidance.

Polymer concrete pit construction offers excellent strength to weight ratio, excellent electrical resistivity, low porosity, and high resistance to chemicals, weathering, biological attack.

Weather Resistant Access Covers

All access covers have IP4X (AS 60529) protection against ingress of foreign objects. **Rhinocast®** access covers offer water & gas tightness to AS 3996.

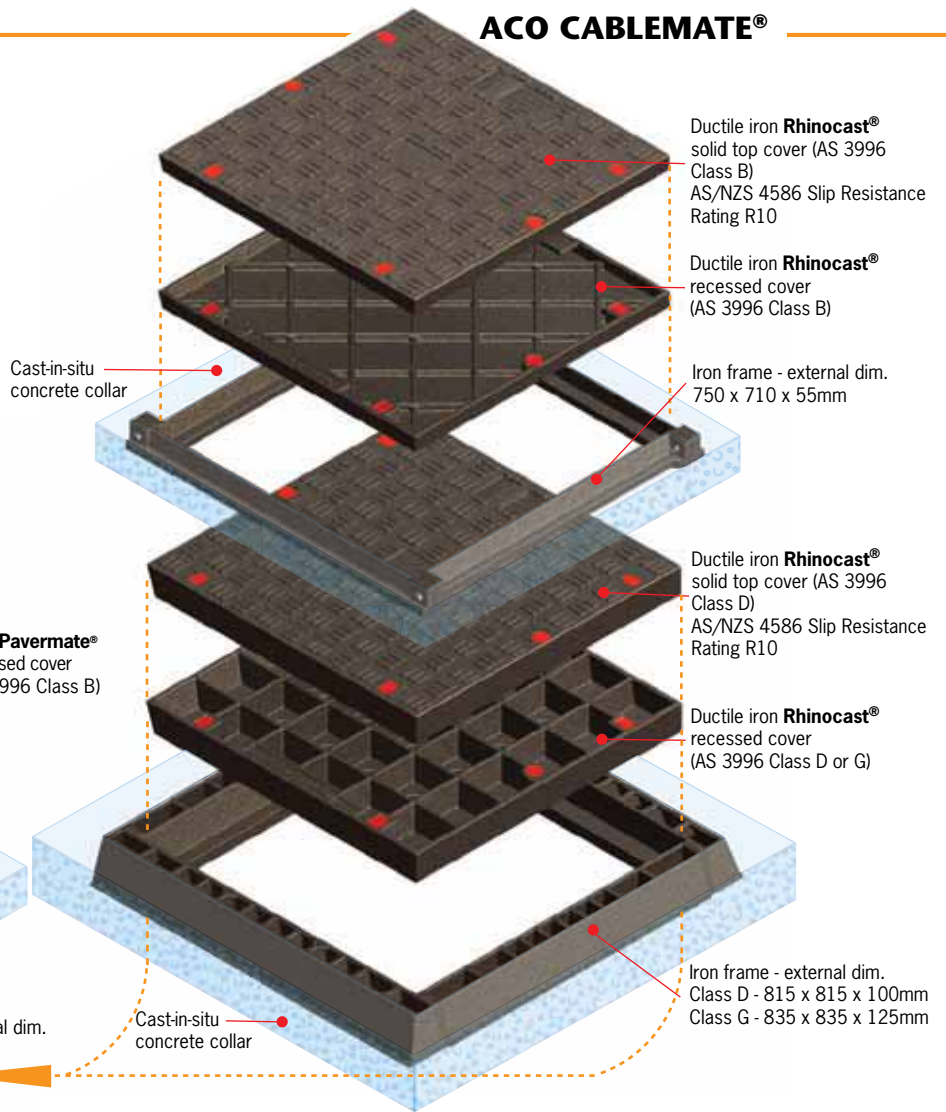
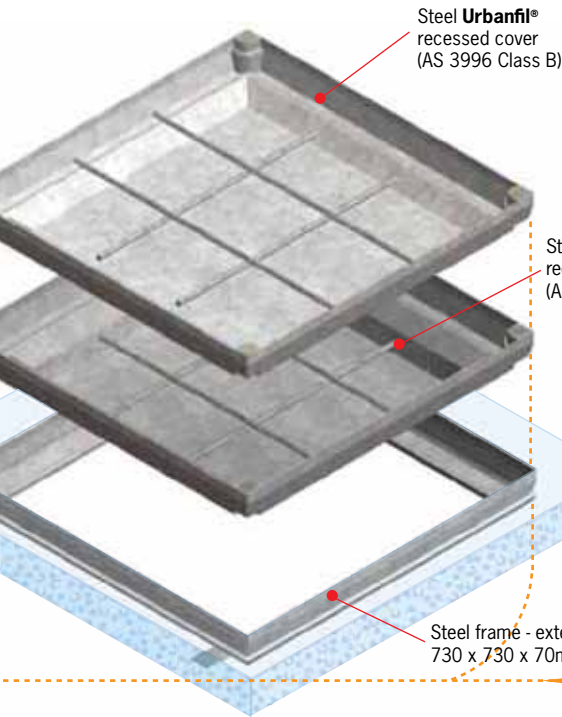

Type 66 Pit Parts List⁶

Description	Part No.	Weight (kg)
Type 66 polymer concrete pit	75105	62
Type 66H polymer concrete pit (915mm deep)	75226	116
Type 66 polymer concrete riser (adds 300mm to pit depth)	75126	37
Lids & Covers		Cover ¹ Total
Polymer concrete lid (AS 3996 Class A) - Blank	75149	24 24
Polymer concrete lid (AS 3996 Class A) - Communications	75154	24 24
Polymer concrete lid (AS 3996 Class A) - Electricity	75160	24 24
Steel lid (AS 3996 Class B)	76620	17 17
Steel PowerLok® lid (AS 3996 Class B) ^{2,3}	76630	22 22
Steel Urbanfil® recessed cover (AS 3996 Class B) ⁴	81565	15 22
Steel Pavermate® recessed cover (AS 3996 Class B) ⁴	81948	18 24
Ductile iron Rhinocast® recessed cover (AS 3996 Class B) ⁵	85045	36 60
Ductile iron Rhinocast® solid top cover (AS 3996 Class B) ⁵	85222	35 63
Ductile iron Rhinocast® recessed cover (AS 3996 Class D) ⁵	89041	62 116
Ductile iron Rhinocast® solid top cover (AS 3996 Class D) ⁵	89235	65 125
Ductile iron Rhinocast® recessed cover (AS 3996 Class G) ⁵	87044	135 200

Notes:

- Lid & access cover weights are provided as lifting weight (individual cover parts) and total weight. Recessed cover weights do not include pavement infill; for approx. lifting weight - **Urbanfil®**/**Pavermate®** covers - multiply weight by '7'; **Rhinocast®** covers multiply weight by '1.5'.
- All lids are supplied with brackets and support bars where applicable.
- PowerLok®** lids supplied with locking bolt (padlock not supplied).
- Optional brass edging (Specify 'BE' after part number).
- Optional locking, brass or stainless steel edging in 12mm or 40mm heights (Specify 'BE' or 'SS' and height after part number).
- For Accessories (e.g. identification plates, divider brackets, cable hanger brackets see pg 43).

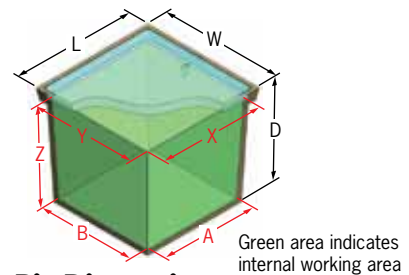

Pit Dimensions

Internal working area	66 (mm)	66H (mm)
A	530	520
B	530	520
X	590	580
Y	590	580
Z	550	840
Overall dimensions (mm)		
L	665	665
W	665	665
D	620	915

Notes:

- Using risers will increase pit depth (Z & D) by depth of riser.
- Access covers will increase depth of pit by height of concrete collar - allowance should be made for concrete collar during pit installation. See pg 82 for excavation details.

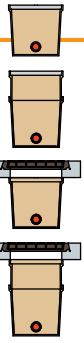

Type 99 Pit

Length 1,010mm L W
 Width 1,010mm D
 Depth 580mm

Up to 880mm (1 riser)
 1,180mm (2 risers)

Product Selection Steps

Once pit type is determined:

1. Determine if riser(s) is required.
2. Select lid or access cover (adds additional depth) to suit project application.

POLYMER CONCRETE

Lids

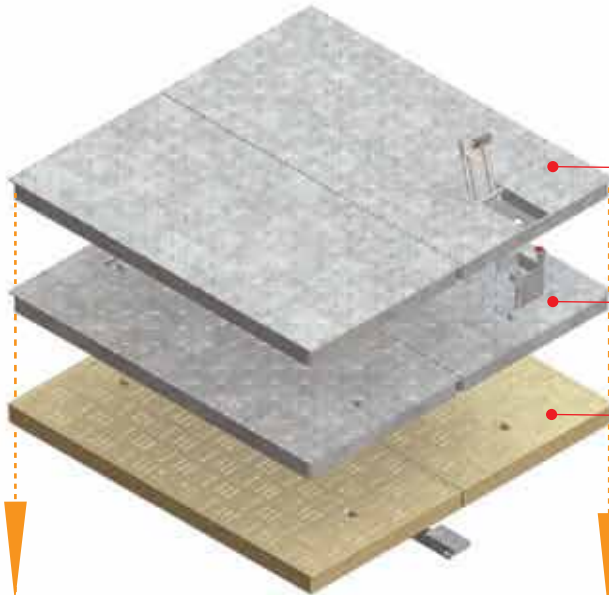

Steel **PowerLok**® 2-part lid (AS 3996 Class B)
 AS/NZS 4586 Slip Resistance Rating R10.
 IP2XD (AS 60529) protection against ingress of foreign objects when hatch is closed.

Steel 2-part lid (AS 3996 Class B)
 AS/NZS 4586 Slip Resistance Rating R10.
 IP4X (AS 60529) protection against ingress of foreign objects if fitted with universal plug.

Polymer concrete 2-part lid (AS 3996 Class A)
 AS/NZS 4586 Slip Resistance Rating R10.
 IP4X (AS 60529) protection against ingress of foreign objects if fitted with universal plug.

Riser

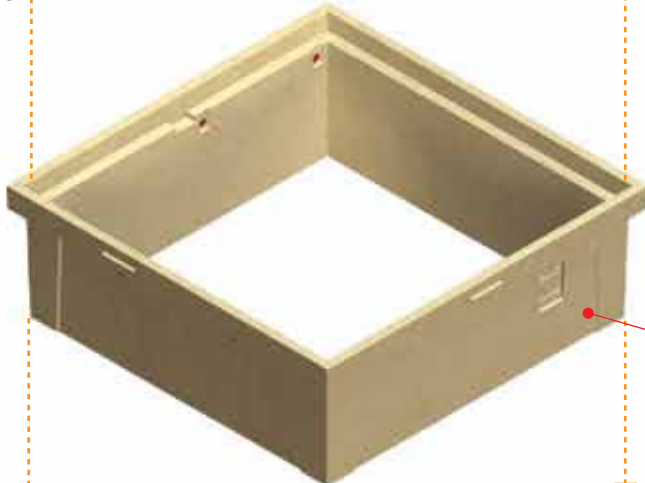

Note: Access covers fit above pit/riser, refer to pg 80 for installation guidelines.

Optional riser to increase pit depth, riser rebate is identical to pit rebate and with lid, offers the same IP protection. Can be cut to required height. ACO recommends no more than 2 risers. Each riser adds 300mm depth.

Pit

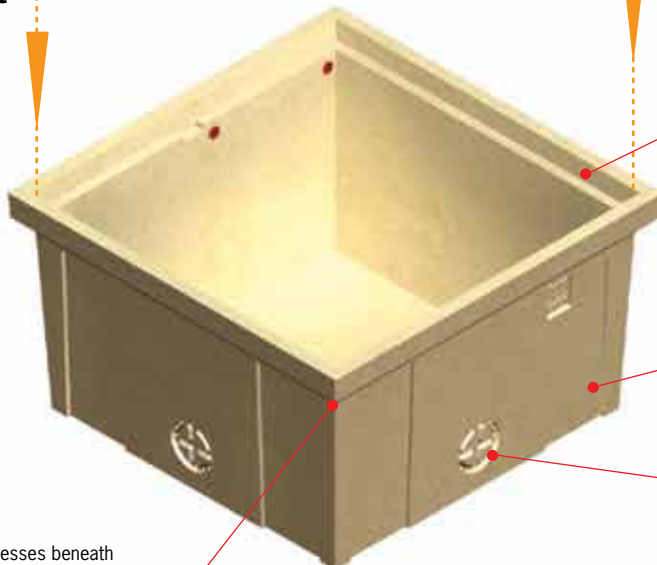

Lids fit into rebate at top of pit, whilst access covers must be installed in a cast in situ concrete collar.

Polymer concrete pit construction offers excellent strength to weight ratio, excellent electrical resistivity, low porosity, and high resistance to chemicals, weathering, biological attack.

Holesaw guides for conduit entry - holes can be cut anywhere on side walls. The maximum number of holes recommended per pit is limited by conduit quantity and size. Contact ACO for guidance.

Recesses beneath rebate on opposite corners to fit ACO's lifting device. See page 43.

Weather Resistant Access Covers

All access covers have IP4X (AS 60529) protection against ingress of foreign objects. **Rhinocast®** access covers offer water & gas tightness to AS 3996.

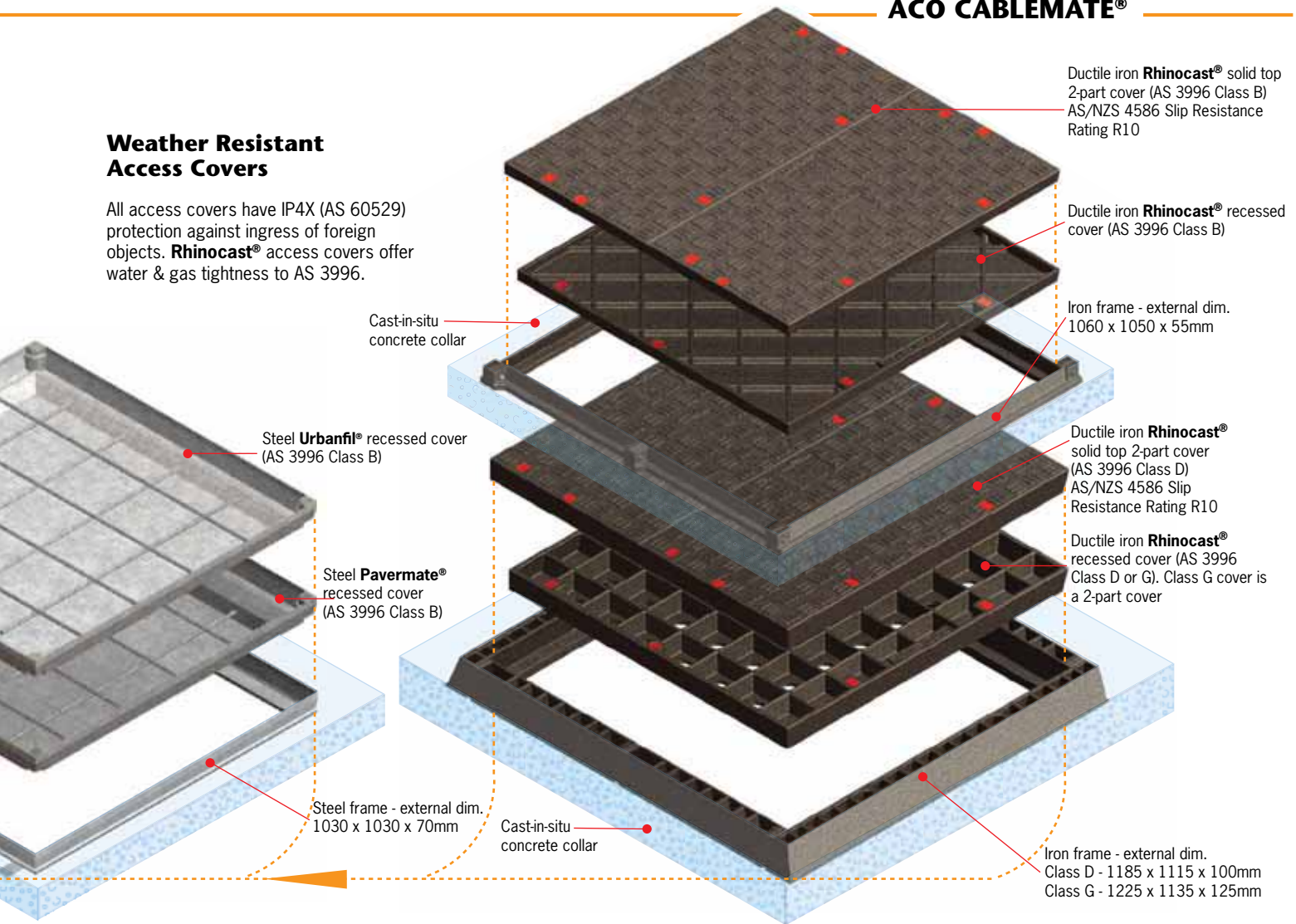

Type 99 Pit Parts List⁶

Description	Part No.	Weight (kg)		
Type 99 polymer concrete pit	75489	147		
Type 99 polymer concrete riser (adds 300mm to pit depth)	75500	67		
Lids & Covers			Cover¹	Total
Polymer concrete 2-part lid (AS 3996 Class A) - Blank ²	75525	29	62	
Polymer concrete 2-part lid (AS 3996 Class A) - Communications ²	75532	29	62	
Polymer concrete 2-part lid (AS 3996 Class A) - Electricity ²	75541	29	62	
Steel 2-part lid (AS 3996 Class B) ²	79920	20	45	
Steel PowerLok® 2-part lid (AS 3996 Class B) ^{2,3}	79930	25	45	
Steel Urbanfil® recessed cover (AS 3996 Class B) ⁴	81645	31	40	
Steel Pavermate® recessed cover (AS 3996 Class B) ⁴	81992	35	45	
Ductile iron Rhinocast® recessed cover (AS 3996 Class B) ⁵	85093	86	115	
Ductile iron Rhinocast® solid top 2-part cover (AS 3996 Class B) ⁵	89953	48	149	
Ductile iron Rhinocast® recessed cover (AS 3996 Class D) ⁵	89093	136	199	
Ductile iron Rhinocast® solid top 2-part cover (AS 3996 Class D) ⁵	89955	80	244	
Ductile iron Rhinocast® recessed 2-part cover (AS 3996 Class G) ⁵	87568	145	380	

Notes:

- Lid & access cover weights are provided as lifting weight (individual cover parts) and total weight. Recessed cover weights do not include pavement infill; for approx. lifting weight - **Urbanfil®/Pavermate®** covers - multiply weight by '7'; **Rhinocast®** covers multiply weight by '1.5'.
- All lids are supplied with brackets and support bars where applicable.
- PowerLok®** lids supplied with locking bolt (padlock not supplied).
- Optional brass edging (Specify 'BE' after part number).
- Optional locking, brass or stainless steel edging in 12mm or 40mm heights (Specify 'BE' or 'SS' and height after part number).
- For Accessories (e.g. identification plates, divider brackets, cable hanger brackets see pg 43).

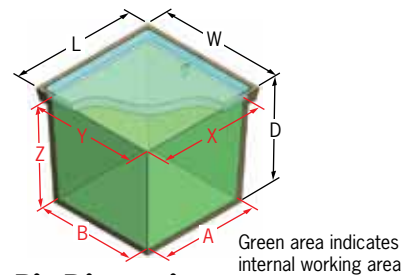

Pit Dimensions

Internal working area	(mm)
A	820
B	820
X	875
Y	875
Z	510
Overall dimensions	(mm)
L	1010
W	1010
D	580

Notes:

- Using risers will increase pit depth (Z & D) by depth of riser.
- Access covers will increase depth of pit by height of concrete collar - allowance should be made for concrete collar during pit installation. See pg 82 for excavation details.

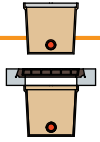

Type 52 Pit

Length	505mm	L	W
Width	220mm		D
Depth	435mm		



Product Selection Steps

Once pit type is determined:

1. Select lid or access cover (adds additional depth) to suit project application.

POLYMER CONCRETE

Lids

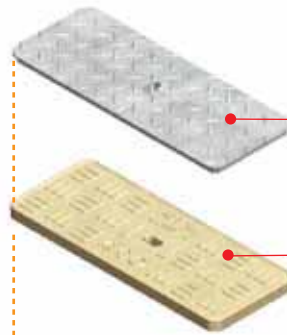

Steel lid (AS 3996 Class B)
AS/NZS 4586 Slip Resistance Rating R10.
IP4X (AS 60529) protection against ingress of foreign objects if fitted with universal plug.
If a locking lid is required, contact ACO.

Polymer concrete lid (AS 3996 Class A)
AS/NZS 4586 Slip Resistance Rating R10.
IP4X (AS 60529) protection against ingress of foreign objects if fitted with universal plug.

Pit



Note: Access covers fit above pit, refer to pg 80 for installation guidelines.

Lids fit into rebate at top of pit, whilst access covers must be installed in a cast in situ concrete collar.

Holesaw guides for conduit entry - holes can be cut anywhere on side walls. The maximum number of holes recommended per pit is limited by conduit quantity and size. Contact ACO for guidance.

Polymer concrete pit construction offers excellent strength to weight ratio, excellent electrical resistivity, low porosity, and high resistance to chemicals, weathering, biological attack.

Weather Resistant Access Covers

All access covers have IP4X (AS 60529) protection against ingress of foreign objects. **Rhinocast®** access covers offer water & gas tightness to AS 3996.

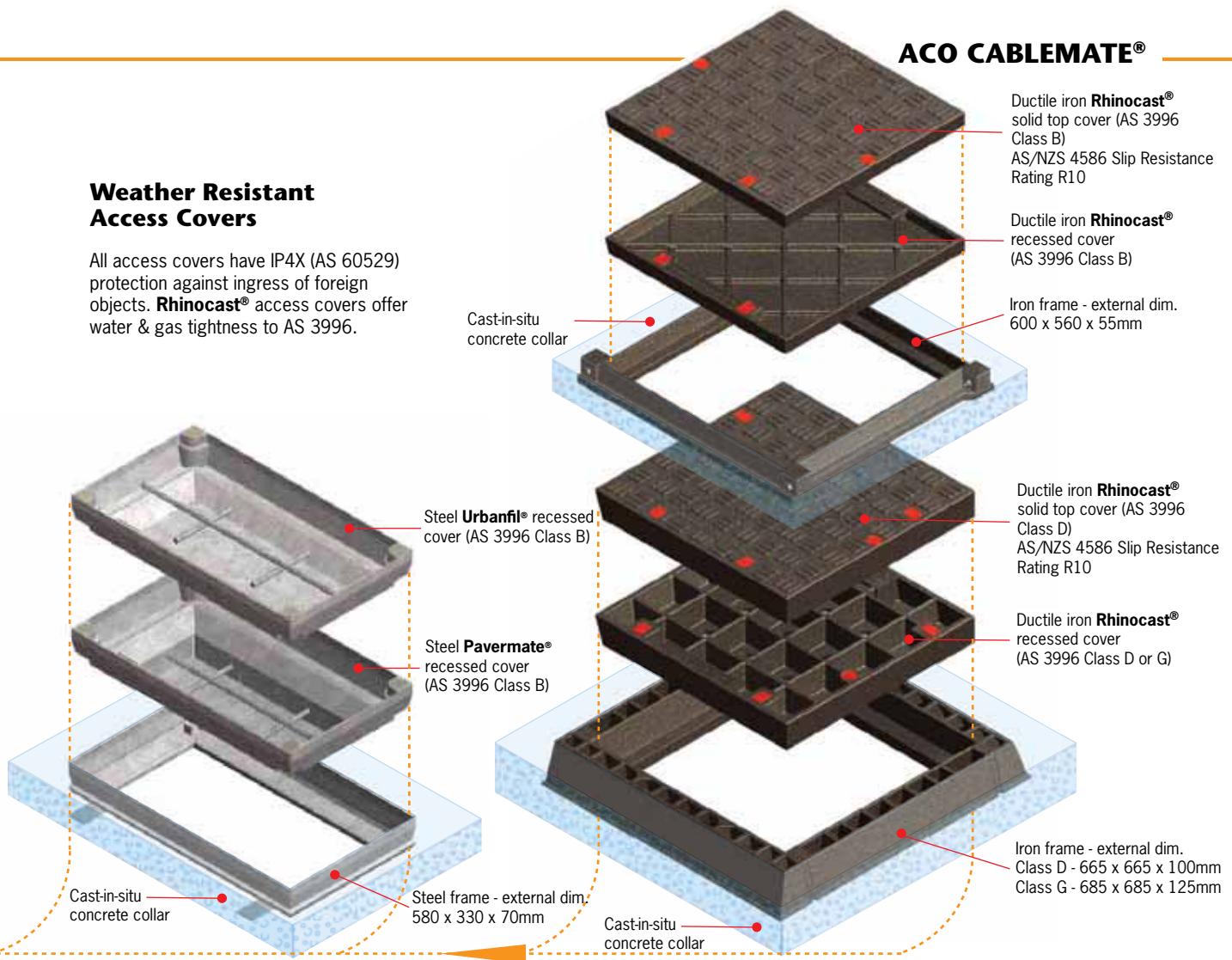

Type 52 Pit Parts List⁴

Description	Part No.	Weight (kg)	
Type 52 polymer concrete pit	74651	19	
Lids & Covers		Cover ¹	Total
Polymer concrete lid (AS 3996 Class A) - Blank	74675	5	5
Polymer concrete lid (AS 3996 Class A) - Communications	74682	5	5
Polymer concrete lid (AS 3996 Class A) - Electricity	74696	5	5
Steel lid (AS 3996 Class B)	75220	3	3
Steel Urbanfil® recessed cover (AS 3996 Class B) ²	80150	8	13
Steel Pavermate® recessed cover (AS 3996 Class B) ²	80151	8	13
Ductile iron Rhinocast® recessed cover (AS 3996 Class B) ³	85014	28	40
Ductile iron Rhinocast® solid top cover (AS 3996 Class B) ³	85249	20	44
Ductile iron Rhinocast® recessed cover (AS 3996 Class D) ³	89013	42	83
Ductile iron Rhinocast® solid top cover (AS 3996 Class D) ³	89268	46	86
Ductile iron Rhinocast® recessed cover (AS 3996 Class G) ³	87016	86	138

Notes:

- Lid & access cover weights are provided as lifting weight (individual cover parts) and total weight. Recessed cover weights do not include pavement infill; for approx. lifting weight - **Urbanfil®**/**Pavermate®** covers - multiply weight by '7'; **Rhinocast®** covers multiply weight by '1.5'.
- Optional brass edging (Specify 'BE' after part number).
- Optional locking, brass or stainless steel edging in 12mm or 40mm heights (Specify 'BE' or 'SS' and height after part number).
- For Accessories (e.g. identification plates, divider brackets, cable hanger brackets see pg 43).

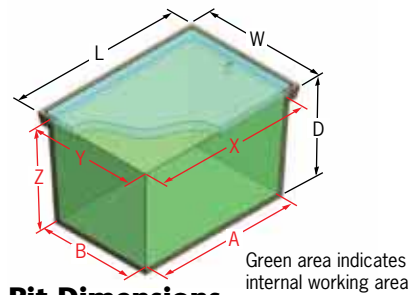

Pit Dimensions

Internal working area	(mm)
A	370
B	115
X	430
Y	145
Z	395
Overall dimensions	(mm)
L	505
W	220
D	435

Notes:

- Access covers will increase depth of pit by height of concrete collar - allowance should be made for concrete collar during pit installation. See pg 82 for excavation details.

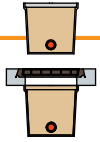

Type 63 Pit

Length	645mm	
Width	300mm	
Depth	740mm	



Product Selection Steps

Once pit type is determined:

1. Select lid or access cover (adds additional depth) to suit project application.

POLYMER CONCRETE

Lids

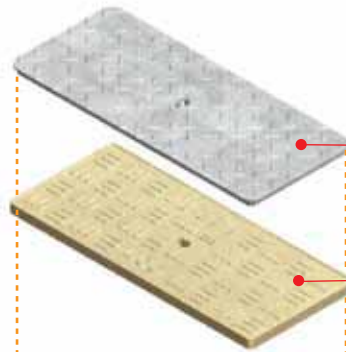

Steel lid (AS 3996 Class B)
AS/NZS 4586 Slip Resistance Rating R10.
IP4X (AS 60529) protection against ingress of foreign objects if fitted with universal plug. If a locking lid is required, contact ACO.

Polymer concrete lid (AS 3996 Class A)
AS/NZS 4586 Slip Resistance Rating R10.
IP4X (AS 60529) protection against ingress of foreign objects if fitted with universal plug.

Pit



Note: Access covers fit above pit, refer to pg 80 for installation guidelines.

Lids fit into rebate at top of pit, whilst access covers must be installed in a cast in situ concrete collar.

Holesaw guides for conduit entry - holes can be cut anywhere on side walls. The maximum number of holes recommended per pit is limited by conduit quantity and size. Contact ACO for guidance.

Polymer concrete pit construction offers excellent strength to weight ratio, excellent electrical resistivity, low porosity, and high resistance to chemicals, weathering, biological attack.

Weather Resistant Access Covers

All access covers have IP4X (AS 60529) protection against ingress of foreign objects. **Rhinocast®** access covers offer water & gas tightness to AS 3996.

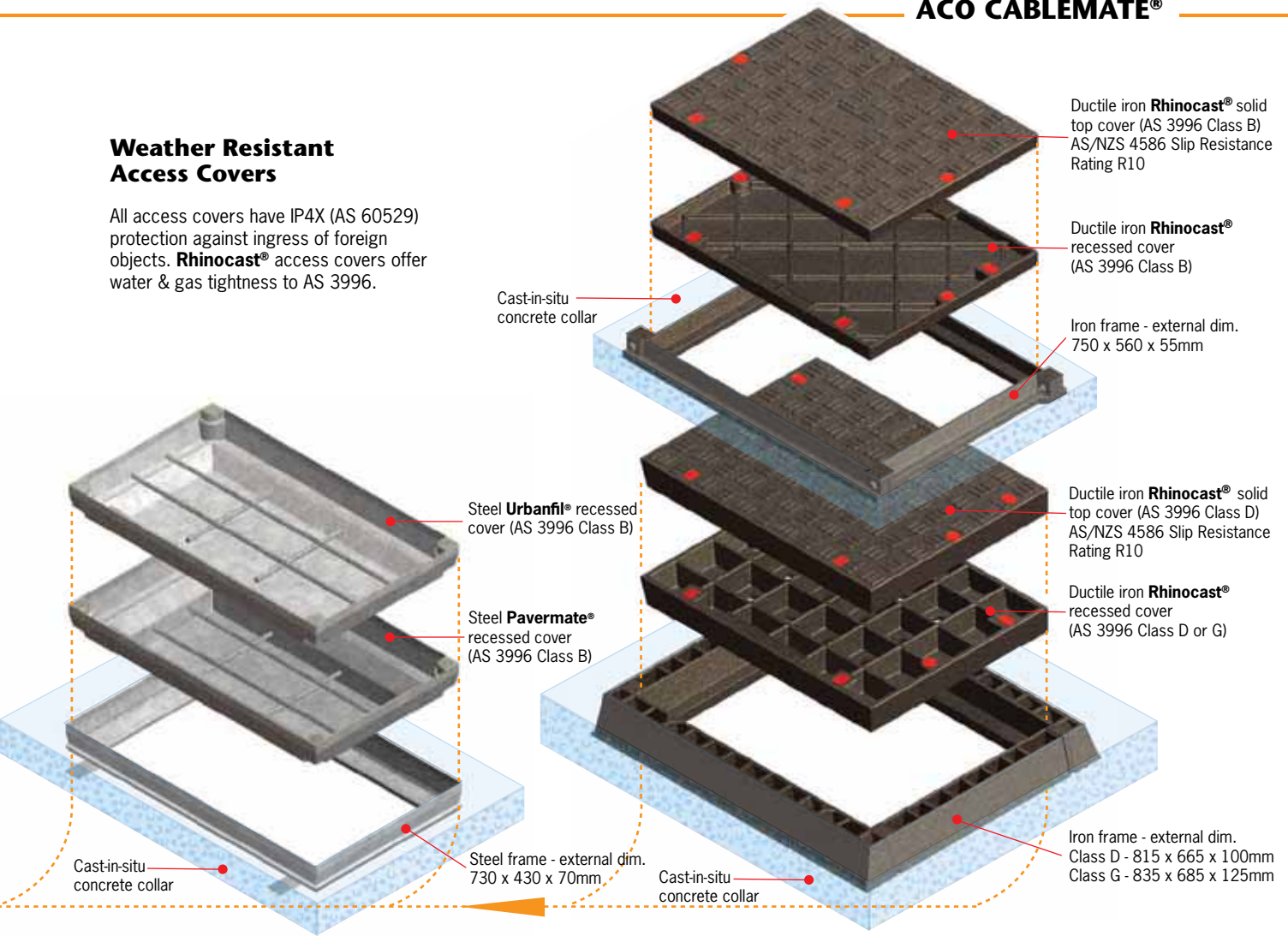

Type 63 Pit Parts List⁴

Description	Part No.	Weight (kg)	
Type 63 polymer concrete pit	74747	52	
Lids & Covers		Cover ¹	Total
Polymer concrete lid (AS 3996 Class A) - Blank	74765	9	9
Polymer concrete lid (AS 3996 Class A) - Communications	74772	9	9
Polymer concrete lid (AS 3996 Class A) - Electricity	74786	9	9
Steel lid (AS 3996 Class B)	76320	6	6
Steel Urbanfil® recessed cover (AS 3996 Class B) ²	81225	11	16
Steel Pavermate® recessed cover (AS 3996 Class B) ²	81340	11	16
Ductile iron Rhinocast® recessed cover (AS 3996 Class B) ³	85037	28	49
Ductile iron Rhinocast® solid top cover (AS 3996 Class B) ³	85236	28	47
Ductile iron Rhinocast® recessed cover (AS 3996 Class D) ³	89034	51	99
Ductile iron Rhinocast® solid top cover (AS 3996 Class D) ³	89251	51	105
Ductile iron Rhinocast® recessed cover (AS 3996 Class G) ³	87039	104	163

Notes:

- Lid & access cover weights are provided as lifting weight (individual cover parts) and total weight. Recessed cover weights do not include pavement infill; for approx. lifting weight - **Urbanfil®**/**Pavermate®** covers - multiply weight by '7'; **Rhinocast®** covers multiply weight by '1.5'.
- Optional brass edging (Specify 'BE' after part number).
- Optional locking, brass or stainless steel edging in 12mm or 40mm heights (Specify 'BE' or 'SS' and height after part number).
- For Accessories (e.g. identification plates, divider brackets, cable hanger brackets see pg 43).

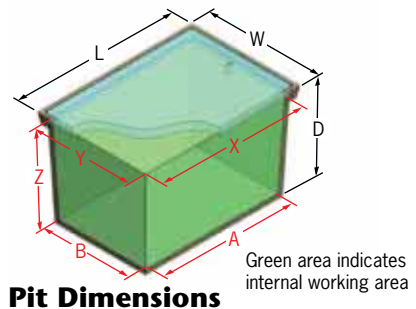

Pit Dimensions

Internal working area	(mm)
A	510
B	180
X	585
Y	235
Z	690
Overall dimensions	(mm)
L	645
W	300
D	740

Notes:

- Access covers will increase depth of pit by height of concrete collar - allowance should be made for concrete collar during pit installation. See pg 82 for excavation details.

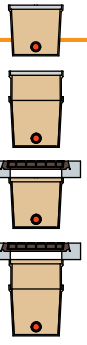

Type 95 Pit

Length	975mm		Up to	
Width	520mm		890mm (1 riser)	
Depth	590mm		1,190mm (2 risers)	

Product Selection Steps

Once pit type is determined:

1. Determine if riser(s) is required.
2. Select lid or access cover (adds additional depth) to suit project application.

POLYMER CONCRETE

Lids

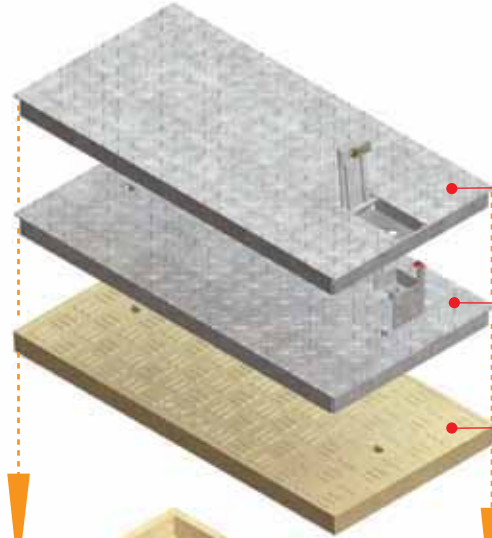

Steel **PowerLok**® lid (AS 3996 Class B)
AS/NZS 4586 Slip Resistance Rating R10.
IP2XD (AS 60529) protection against ingress of foreign objects when hatch is closed.

Steel lid (AS 3996 Class B)
AS/NZS 4586 Slip Resistance Rating R10.
IP4X (AS 60529) protection against ingress of foreign objects if fitted with universal plug.

Polymer concrete lid (AS 3996 Class A)
AS/NZS 4586 Slip Resistance Rating R10.
IP4X (AS 60529) protection against ingress of foreign objects if fitted with universal plug.

Riser



Note: Access covers fit above pit/riser, refer to pg 80 for installation guidelines.

Optional riser to increase pit depth, riser rebate is identical to pit rebate and with lid, offers the same IP protection. Can be cut to required height. ACO recommends no more than 2 risers. Each riser adds 300mm depth.

Pit

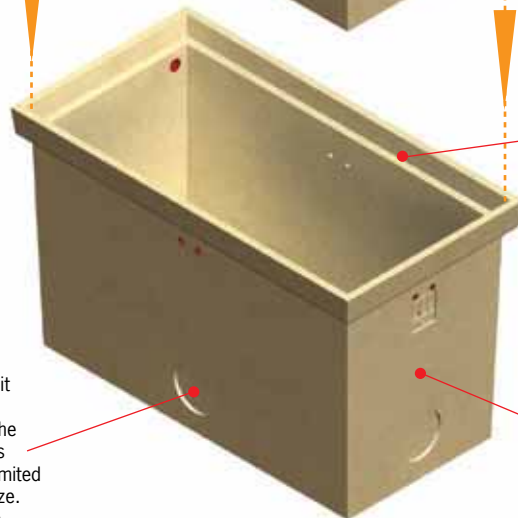

Lids fit into rebate at top of pit, whilst access covers must be installed in a cast in situ concrete collar.

Holesaw guides for conduit entry - holes can be cut anywhere on side walls. The maximum number of holes recommended per pit is limited by conduit quantity and size. Contact ACO for guidance.

Polymer concrete pit construction offers excellent strength to weight ratio, excellent electrical resistivity, low porosity, and high resistance to chemicals, weathering, biological attack.

Weather Resistant Access Covers

All access covers have IP4X (AS 60529) protection against ingress of foreign objects. **Rhinocast®** access covers offer water & gas tightness to AS 3996.

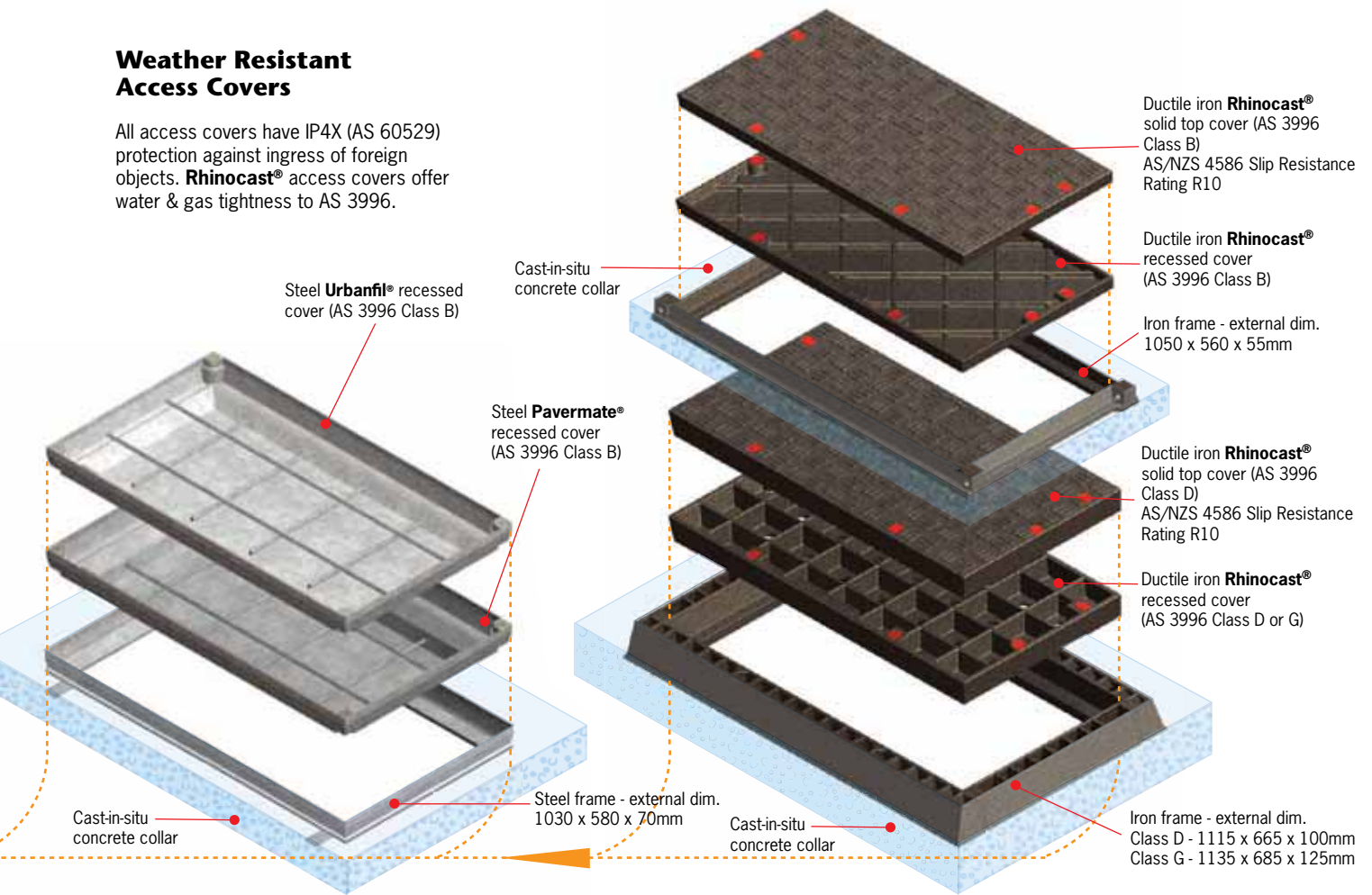

Type 95 Pit Parts List⁶

Description	Part No.	Weight (kg)
Type 95 polymer concrete pit	74845	84
Type 95 polymer concrete riser (adds 300mm to pit depth)	74861	45
Lids & Covers		Cover ¹ Total
Polymer concrete lid (AS 3996 Class A) - Blank	74886	29 29
Polymer concrete lid (AS 3996 Class A) - Communications	74893	29 29
Polymer concrete lid (AS 3996 Class A) - Electricity	74904	29 29
Steel lid (AS 3996 Class B)	79520	20 20
Steel PowerLok® lid (AS 3996 Class B) ^{2,3}	79530	25 25
Steel Urbanfil® recessed cover (AS 3996 Class B) ⁴	81661	18 26
Steel Pavermate® recessed cover (AS 3996 Class B) ⁴	81338	20 28
Ductile iron Rhinocast® recessed cover (AS 3996 Class B) ⁵	85119	45 63
Ductile iron Rhinocast® solid top cover (AS 3996 Class B) ⁵	85208	48 83
Ductile iron Rhinocast® recessed cover (AS 3996 Class D) ⁵	89124	72 130
Ductile iron Rhinocast® solid top cover (AS 3996 Class D) ⁵	89215	80 139
Ductile iron Rhinocast® recessed cover (AS 3996 Class G) ⁵	87082	145 216

Notes:

- Lid & access cover weights are provided as lifting weight (individual cover parts) and total weight. Recessed cover weights do not include pavement infill; for approx. lifting weight - **Urbanfil®**/**Pavermate®** covers - multiply weight by '7'; **Rhinocast®** covers multiply weight by '1.5'.
- All lids are supplied with brackets and support bars where applicable.
- PowerLok®** lids supplied with locking bolt (padlock not supplied).
- Optional brass edging (Specify 'BE' after part number).
- Optional locking, brass or stainless steel edging in 12mm or 40mm heights (Specify 'BE' or 'SS' and height after part number).
- For Accessories (e.g. identification plates, divider brackets, cable hanger brackets see pg 43).

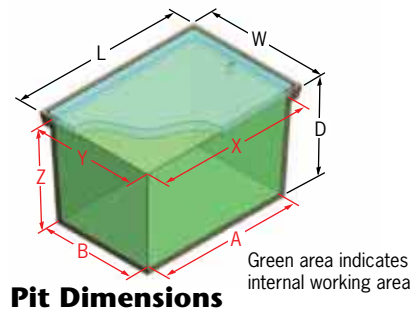

Pit Dimensions

Internal working area	(mm)
A	845
B	385
X	895
Y	435
Z	520
Overall dimensions	(mm)
L	975
W	520
D	590

Notes:

- Using risers will increase pit depth (Z & D) by depth of riser.
- Access covers will increase depth of pit by height of concrete collar - allowance should be made for concrete collar during pit installation. See pg 82 for excavation details.

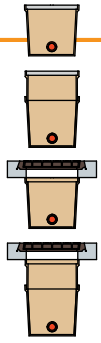

Type 96 Pit

Length	995mm		Up to		
Width	695mm				920mm (1 riser)
Depth	620mm				1,220mm (2 risers)

Product Selection Steps

Once pit type is determined:

1. Determine if riser(s) is required.
2. Select lid or access cover (adds additional depth) to suit project application.

POLYMER CONCRETE

Lids

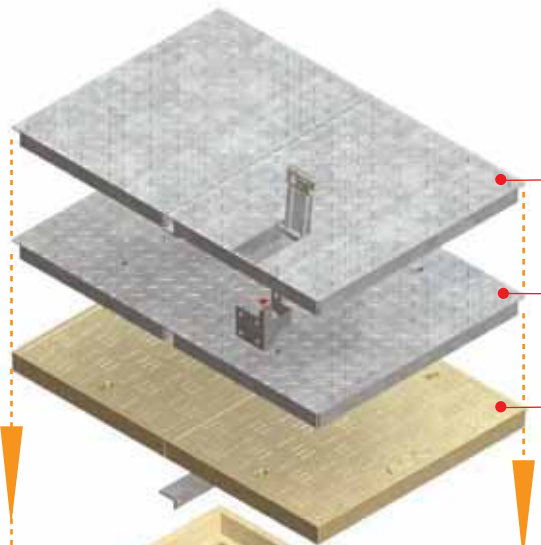

Steel **PowerLok**® 2-part lid (AS 3996 Class B) AS/NZS 4586 Slip Resistance Rating R10. IP2XD (AS 60529) protection against ingress of foreign objects when hatch is closed.

Steel 2-part lid (AS 3996 Class B) AS/NZS 4586 Slip Resistance Rating R10. IP4X (AS 60529) protection against ingress of foreign objects if fitted with universal plug.

Polymer concrete 2-part lid (AS 3996 Class A) AS/NZS 4586 Slip Resistance Rating R10. IP4X (AS 60529) protection against ingress of foreign objects if fitted with universal plug.

Riser

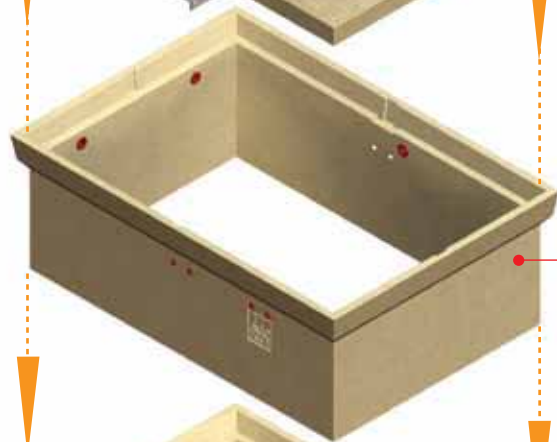

Note: Access covers fit above pit/riser, refer to pg 80 for installation guidelines.

Optional riser to increase pit depth, riser rebate is identical to pit rebate and with lid, offers the same IP protection. Can be cut to required height. ACO recommends no more than 2 risers. Each riser adds 300mm depth.

Pit

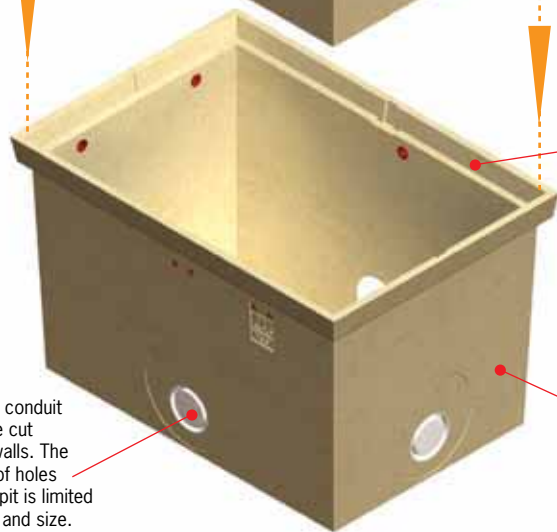

Lids fit into rebate at top of pit, whilst access covers must be installed in a cast in situ concrete collar.

Holesaw guides for conduit entry - holes can be cut anywhere on side walls. The maximum number of holes recommended per pit is limited by conduit quantity and size. Contact ACO for guidance.

Polymer concrete pit construction offers excellent strength to weight ratio, excellent electrical resistivity, low porosity, and high resistance to chemicals, weathering, biological attack.

Weather Resistant Access Covers

All access covers have IP4X (AS 60529) protection against ingress of foreign objects. **Rhinocast®** access covers offer water & gas tightness to AS 3996.

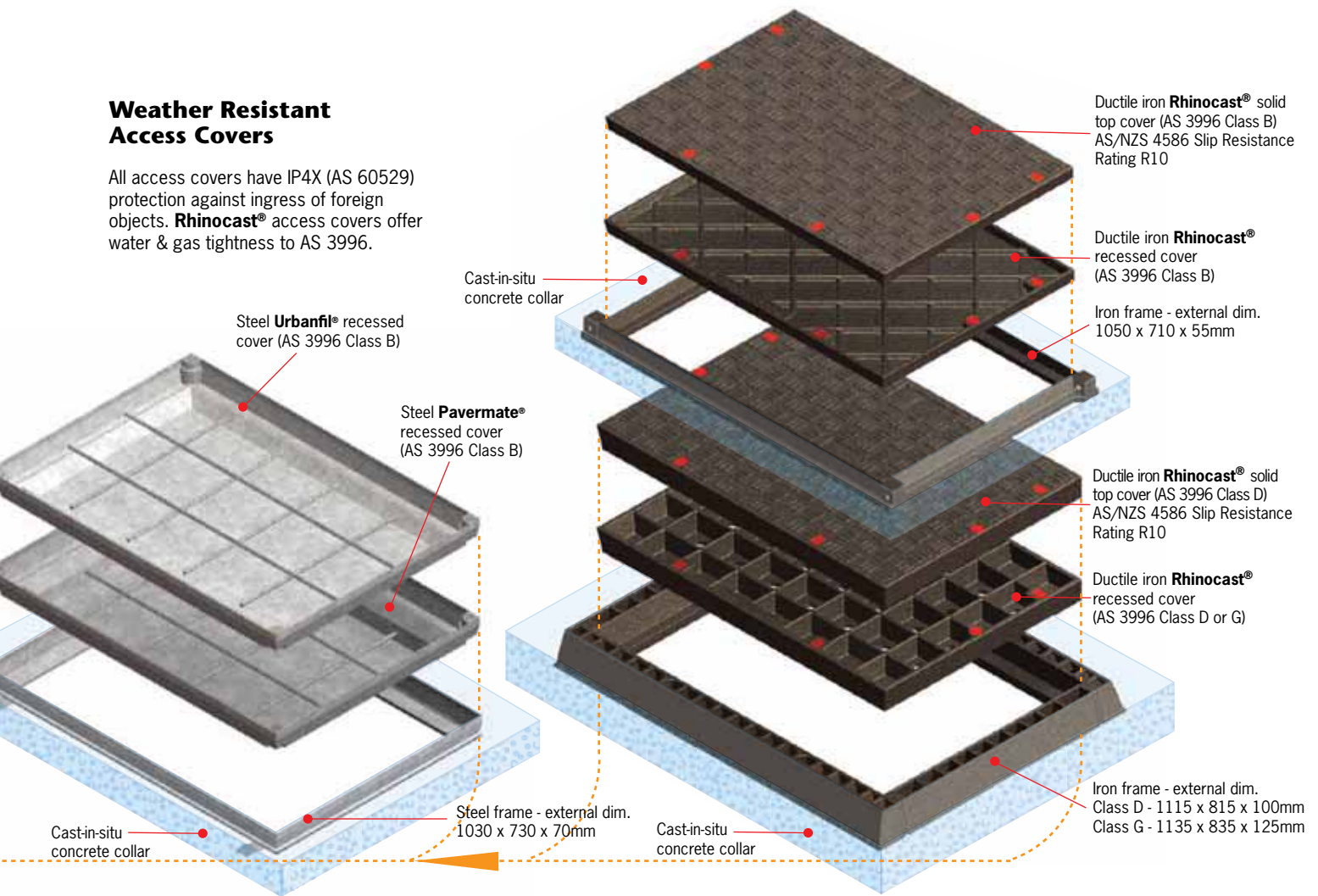

Type 96 Pit Parts List⁶

Description	Part No.	Weight (kg)
Type 96 polymer concrete pit	74429	95
Type 96 polymer concrete riser (adds 300mm to pit depth)	74463	55
Lids & Covers		Cover ¹ Total
Polymer concrete 2-part lid (AS 3996 Class A) - Blank ²	74560	22 46
Polymer concrete 2-part lid (AS 3996 Class A) - Communications ²	74555	22 46
Polymer concrete 2-part lid (AS 3996 Class A) - Electricity ²	74550	22 46
Steel 2-part lid (AS 3996 Class B)	79620	15 30
Steel PowerLok® 2-part lid (AS 3996 Class B) ^{2,3}	79630	20 39
Steel Urbanfil® recessed cover (AS 3996 Class B) ⁴	82018	21 30
Steel Pavermate® recessed cover (AS 3996 Class B) ⁴	81364	22 30
Ductile iron Rhinocast® recessed cover (AS 3996 Class B) ⁵	85078	57 83
Ductile iron Rhinocast® solid top cover (AS 3996 Class B) ⁵	85253	57 87
Ductile iron Rhinocast® recessed cover (AS 3996 Class D) ⁵	89072	88 149
Ductile iron Rhinocast® solid top cover (AS 3996 Class D) ⁵	89276	102 165
Ductile iron Rhinocast® recessed cover (AS 3996 Class G) ⁵	87075	180 266

Notes:

- Lid & access cover weights are provided as lifting weight (individual cover parts) and total weight. Recessed cover weights do not include pavement infill; for approx. lifting weight - **Urbanfil®**/**Pavermate®** covers - multiply weight by '7'; **Rhinocast®** covers multiply weight by '1.5'.
- All lids are supplied with brackets and support bars where applicable.
- PowerLok®** lids supplied with locking bolt (padlock not supplied).
- Optional brass edging (Specify 'BE' after part number).
- Optional locking, brass or stainless steel edging in 12mm or 40mm heights (Specify 'BE' or 'SS' and height after part number).
- For Accessories (e.g. identification plates, divider brackets, cable hanger brackets see pg 43).

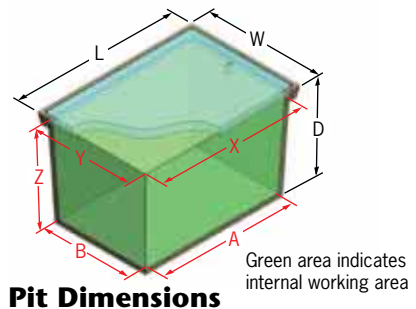

Pit Dimensions

Internal working area	(mm)
A	850
B	555
X	900
Y	600
Z	550
Overall dimensions	(mm)
L	995
W	695
D	620

Notes:

- Using risers will increase pit depth (Z & D) by depth of riser.
- Access covers will increase depth of pit by height of concrete collar - allowance should be made for concrete collar during pit installation. See pg 82 for excavation details.

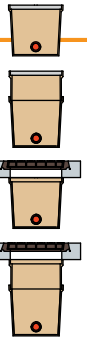

Type 8 Pit

Length	1,395mm		Up to	
Width	580mm		1,200mm (1 riser)	
Depth	900mm		1,500mm (2 risers)	

Product Selection Steps

Once pit type is determined:

1. Determine if riser(s) is required.
2. Select lid or access cover (adds additional depth) to suit project application.

POLYMER CONCRETE

Lids

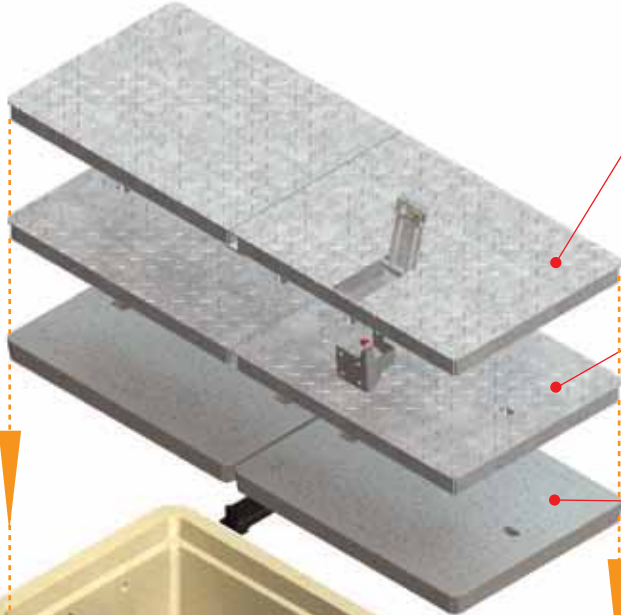

Steel **PowerLok**® 2-part lid (AS 3996 Class B) AS/NZS 4586 Slip Resistance Rating R10. IP2XD (AS 60529) protection against ingress of foreign objects when hatch is closed.

Steel 2-part lid (AS 3996 Class B) AS/NZS 4586 Slip Resistance Rating R10. IP4X (AS 60529) protection against ingress of foreign objects if fitted with universal plug.

Cement concrete 2-part lid (AS 3996 Class A) AS/NZS 4586 Slip Resistance Rating R9. IP4X (AS 60529) protection against ingress of foreign objects if fitted with universal plug.

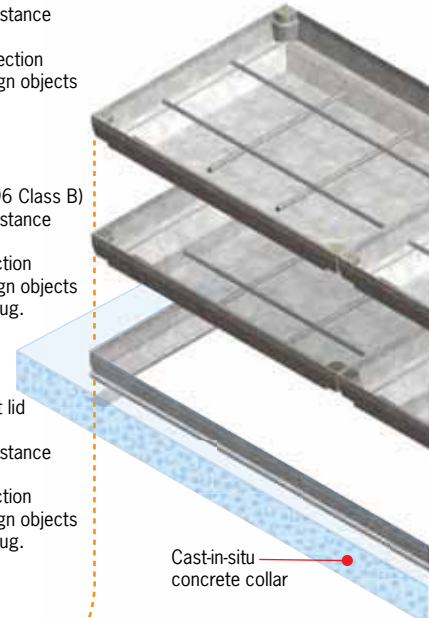

Cast-in-situ concrete collar

Riser

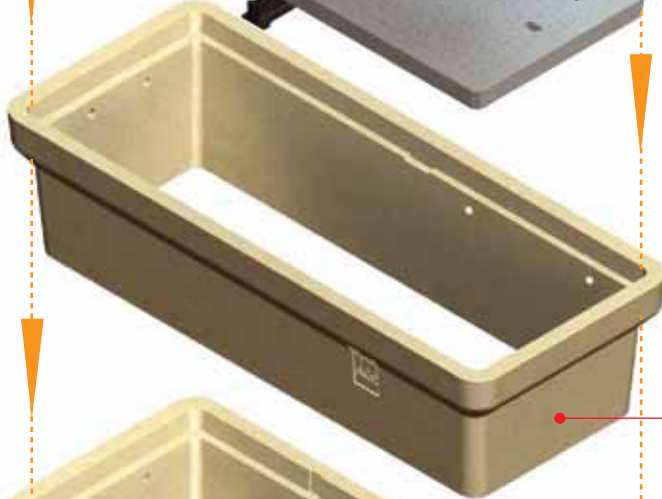

Note: Access covers fit above pit/riser, refer to pg 80 for installation guidelines.

Optional riser to increase pit depth, riser rebate is identical to pit rebate and with lid, offers the same IP protection. Can be cut to required height. ACO recommends no more than 2 risers. Each riser adds 300mm depth.

Pit



Lids fit into rebate at top of pit, whilst access covers must be installed in a cast in situ concrete collar.

Polymer concrete pit construction offers excellent strength to weight ratio, excellent electrical resistivity, low porosity, and high resistance to chemicals, weathering, biological attack.

Recesses beneath rebate on opposite corners to fit ACO's lifting device. See page 43.

Holesaw guides for conduit entry - holes can be cut anywhere on side walls. The maximum number of holes recommended per pit is limited by conduit quantity and size. Contact ACO for guidance.

Weather Resistant Access Covers

All access covers have IP4X (AS 60529) protection against ingress of foreign objects. **Rhinocast®** access covers offer water & gas tightness to AS 3996.

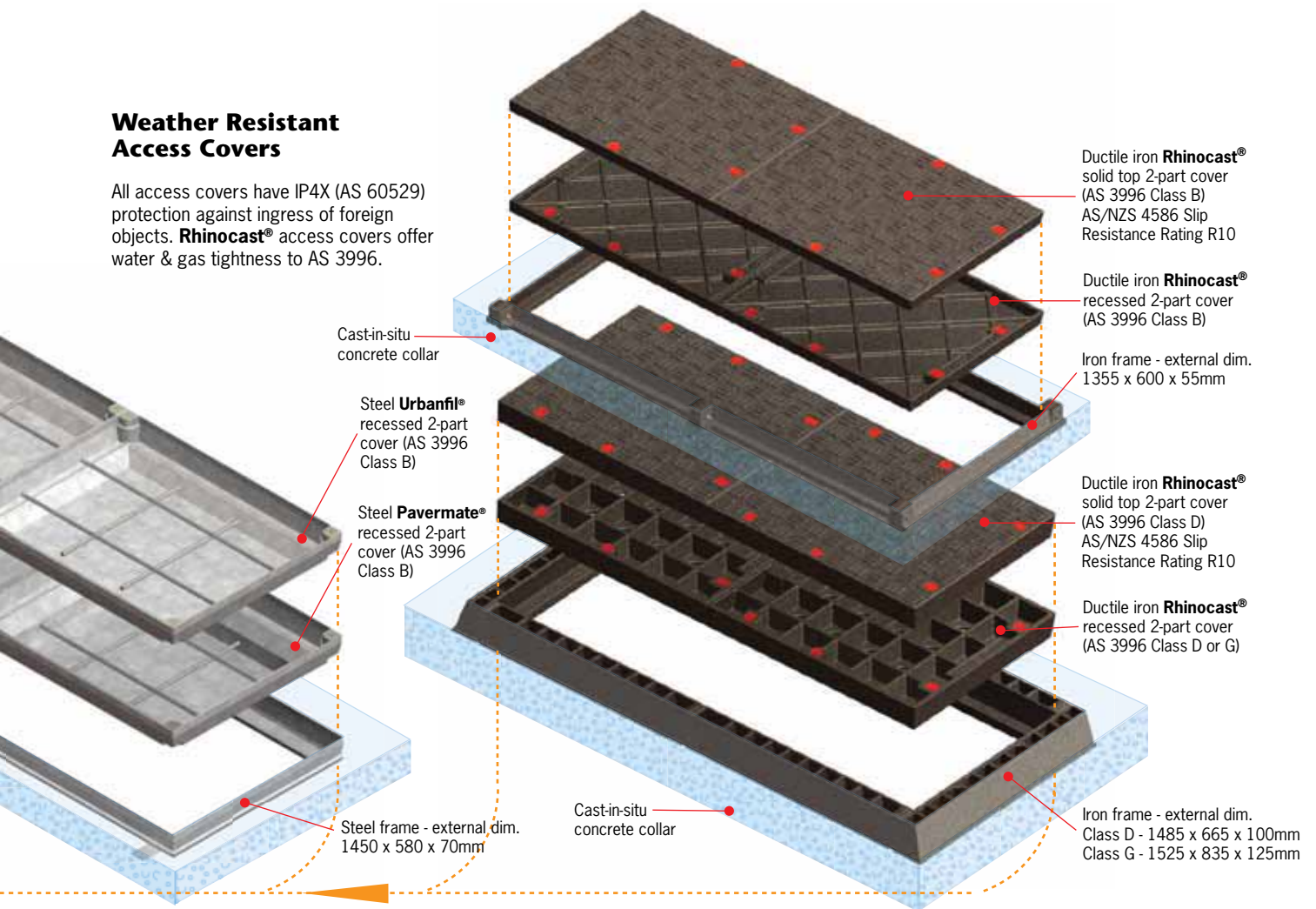

Type 8 Pit Parts List⁶

Description	Part No.	Weight (kg)
Type 8 polymer concrete pit	74991	162
Type 8 polymer concrete riser (adds 300mm to pit depth)	73419	85
Lids & Covers		Cover ¹ Total
Cement concrete 2-part lid (AS 3996 Class A) - Blank ²	75010	33 69
Cement concrete 2-part lid (AS 3996 Class A) - Communications ²	75011	33 69
Cement concrete 2-part lid (AS 3996 Class A) - Electricity ²	75012	33 69
Steel 2-part lid (AS 3996 Class B)	76820	15 31
Steel PowerLok® 2-part lid (AS 3996 Class B) ^{2,3}	76830	20 39
Steel Urbanfil® recessed 2-part cover (AS 3996 Class B) ⁴	82567	13 39
Steel Pavermate® recessed 2-part cover (AS 3996 Class B) ⁴	82373	15 41
Ductile iron Rhinocast® recessed 2-part cover (AS 3996 Class B) ⁵	85433	30 91
Ductile iron Rhinocast® solid top 2-part cover (AS 3996 Class B) ⁵	86853	28 89
Ductile iron Rhinocast® recessed 2-part cover (AS 3996 Class D) ⁵	89431	51 182
Ductile iron Rhinocast® solid top 2-part cover (AS 3996 Class D) ⁵	80855	51 169
Ductile iron Rhinocast® recessed 2-part cover (AS 3996 Class G) ⁵	87463	135 358

Notes:

- Lid & access cover weights are provided as lifting weight (individual cover parts) and total weight. Recessed cover weights do not include pavement infill; for approx. lifting weight - **Urbanfil®/Pavermate®** covers - multiply weight by '7'; **Rhinocast®** covers multiply weight by '1.5'.
- All lids are supplied with brackets and support bars where applicable.
- PowerLok®** lids supplied with locking bolt (padlock not supplied).
- Optional brass edging (Specify 'BE' after part number).
- Optional locking, brass or stainless steel edging in 12mm or 40mm heights (Specify 'BE' or 'SS' and height after part number).
- For Accessories (e.g. identification plates, divider brackets, cable hanger brackets see pg 43).

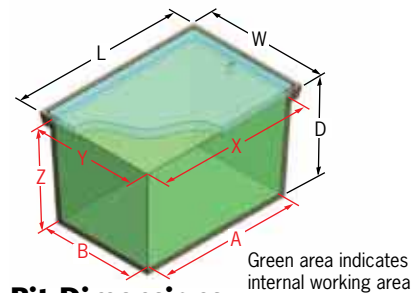

Pit Dimensions

Internal working area	(mm)
A	1130
B	330
X	1265
Y	455
Z	840
Overall dimensions	(mm)
L	1395
W	580
D	900

Notes:

- Using risers will increase pit depth (Z & D) by depth of riser.
- Access covers will increase depth of pit by height of concrete collar - allowance should be made for concrete collar during pit installation. See pg 82 for excavation details.



Earth Rod Pit

Length 200mm L
 Width 200mm W
 Depth 150mm D

150mm

POLYMER CONCRETE

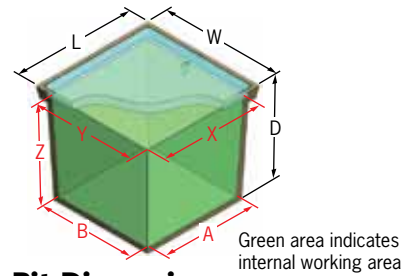
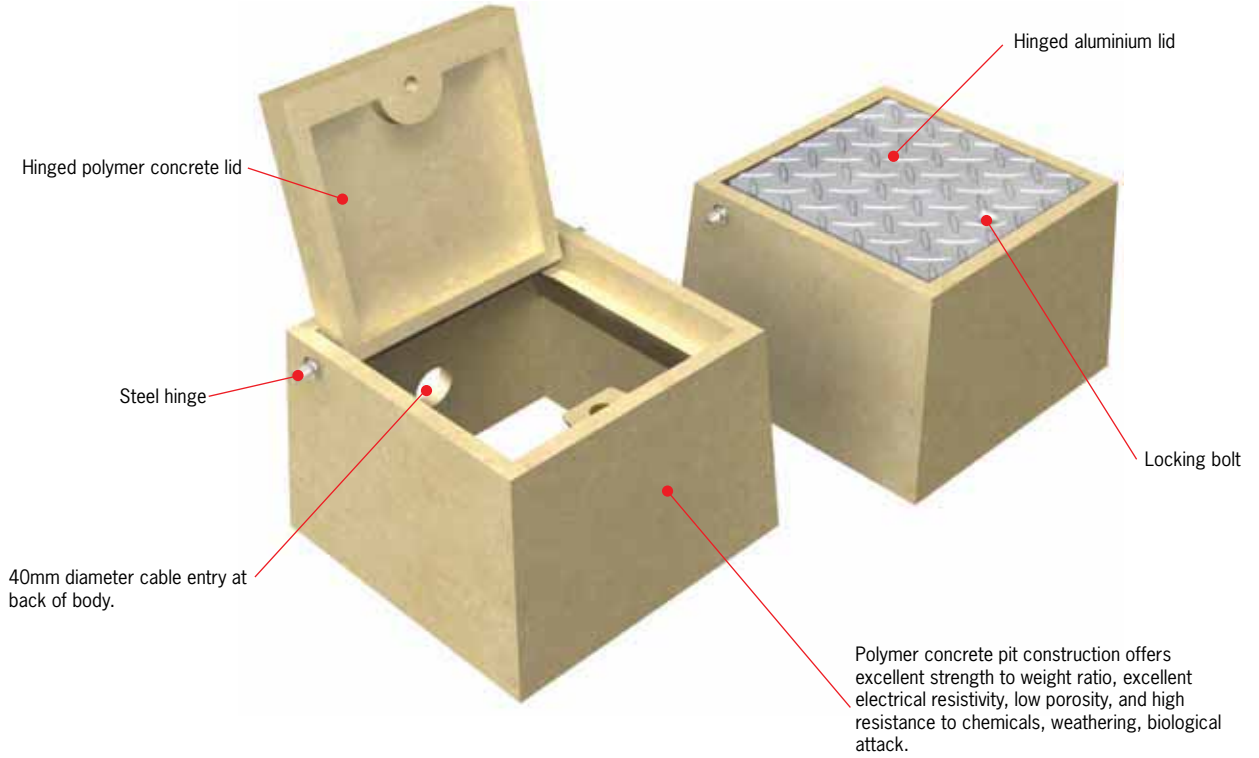

Earth Rod Pit Parts List

Description	Part No.	Weight (kg)
PEP22 Earth Rod Pit with aluminium lid	75780	4
PEP22 Earth Rod Pit with polymer concrete lid	75767	5

Pit Dimensions

Internal working area	(mm)
A	195
B	195
X	150
Y	110
Z	120
Overall dimensions	(mm)
L	220
W	220
D	150

Pit Accessories

To facilitate the installation of cable enclosures along a cable route and to satisfy specific user requirements, a wide range of accessories is offered.

Accessories are designed to assist with installation, services identification, maintenance and keyhole/IP protection.

Polymer concrete pits and plastic pits may require different accessories. The table below will help guide your selection. If in doubt, contact ACO.

Accessories

Description	Compatible with:		Part No.	Weight (kg)
	Polymer Concrete	Plastic Pits		
Pit Additions				
Pit divider angles	✓		76514	0.35
Hanger brackets	✓		76509	0.15
Steel Lid ID				
Brass plate - Electricity	✓	✓	50275	0.05
Brass plate - Communications	✓	✓	50269	0.05
Brass plate - Gas	✓	✓	77420	0.05
PowerLok® Assembly				
PowerLok® bracket packet ¹	✓	✓	76510	0.80
Pit Maintenance				
Polymer concrete repair kit (1L)	✓		02163	1.40
PowerLok® tool (pg 20)	✓	✓	01318	0.20
Cement concrete lid lifter	✓	✓	84307	1.15
Urbanfil®/Pavermate®: lifting key short handle	✓	✓	84306	0.40
Urbanfil®/Pavermate®: allen locking key	✓	✓	84313	0.25
Rhinocast®: lifting key - short handle (pair)	✓	✓	84654	3.60
Rhinocast®: lifting key - long handle (pair)	✓	✓	84854	8.10
Rhinocast®: sealing grease 4kg	✓	✓	73131	4.40
Rhinocast®: sealing grease 20kg	✓	✓	73154	21.80
Installation Devices²				
Certified pit lifter (Type 8 & 99 pits only)	✓		84308	6.10
Holesaw: sintered 95mm system - hex shaft	✓		99096	0.90
Holesaw: sintered 117mm system - hex shaft	✓		99111	1.25
Holesaw: sintered 127mm system - hex shaft	✓		99121	1.30
Holesaw: sintered 152mm system - hex shaft	✓		99151	1.85
Holesaw: sintered 180mm system - hex shaft	✓		99171	1.95
Holesaw: sintered 95mm system - SDS	✓		99095	0.85
Holesaw: sintered 117mm system - SDS	✓		99110	1.35
Holesaw: sintered 127mm system - SDS	✓		99120	1.35
Holesaw: sintered 152mm system - SDS	✓		99150	2.00
Holesaw: sintered 180mm system - SDS	✓		99170	2.55
Keyhole/IP Protection³				
Universal plug ⁴	✓	✓	84625	negligible
Urbanfil®/Pavermate®: round grey plastic caps	✓	✓	84329	negligible
Urbanfil®/Pavermate®: round gold plastic caps	✓	✓	84334	negligible
Rhinocast®: rectangular long red plastic caps	✓	✓	84622	negligible
Rhinocast®: rectangular short red plastic caps	✓	✓	84620	negligible
Rhinocast®: round red plastic caps	✓	✓	84626	negligible

Notes:

- Bracket packets are standard for all PowerLok® lids. Items listed are for replacement purposes only.
- Sintered diamond holesaws are not recommended for plastic pits. ACO recommends using any widely available bi-metal holesaw. If in doubt contact ACO.
- Caps are supplied as standard for all Urbanfil®, Pavermate® & Rhinocast® covers. Items listed are for replacement purposes only.
- Suitable for all non-locking lids.



Universal plug allows lids to meet IP rating IP4X (AS 60529).



Range of lid & access cover lifters.



Range of sintered diamond holesaws for polymer concrete pits.



NATA certified pit lifter for Type 8 & 99 polymer concrete pits.